

# Update Notice

## Handbook PO-701, *Fleet Management* March 1991

Handbook PO-701, *Fleet Management*, was last printed in March 1991. To inform you of changes since that time, we periodically update this online edition of the Handbook. We use vertical bars (i.e., revision bars) in the margin to indicate text changed since March 1991.

This online version of Handbook PO-701 has been updated with *Postal Bulletin* articles through 10-23-08, as follows:

The chapter, subchapter, part, appendix, or section...	titled...	was...	in <i>Postal Bulletin</i> issue number...	with an issue date of...
<b>Chapter 2, Vehicle Operations and Utilization</b>				
221.2	Requesting Vehicles/Services	revised to reflect current information.	22133	7-22-04
242.1	Authorized Passengers	revised to reflect the policy for authorizing non-Postal Service persons to ride as passengers in Postal Service-owned, -rented, or -leased vehicles.	22140	10-28-04
243.4	Accident Report Kits	revised to delete entries for PS Form 4585 and PS Form 4586	22244	10-23-08
245.27	Parking and Securing Vehicle	revised to reflect the policy for whenever a driver dismounts from a vehicle.	21862	3-03-94
245.28	Protection of Mail in Vehicles	revised to reflect updates to vehicle door policies.	22033	9-21-00
245.3	Accident Procedures	revised to delete entries for PS Form 4585 and PS Form 4586	22244	10-23-08
245.46	Automated Vehicle Time Recording Systems	added to note the policy of using automated vehicle time recording systems instead of PS Form 4570, <i>Vehicle Time Record</i> .	21814	4-30-92
261	General	revised to reflect updates to the general policies and procedures for reporting motor vehicle accident investigations.	22120	1-22-04
262	Recording Accidents	revised to reflect updates to the policies and procedures for reporting vehicle accident damage.	22120	1-22-04

<b>The chapter, subchapter, part, appendix, or section...</b>	<b>titled...</b>	<b>was...</b>	<b>in <i>Postal Bulletin</i> issue number...</b>	<b>with an issue date of...</b>
263	Claims for Damage to Postal Service Property	revised to reflect updates regarding claims for private-party damage to Postal Service vehicles.	22120	1-22-04
<b>Chapter 6, Warranty Claims and Defect Reports</b>				
6	Warranty Claims and Defect Reports	revised in its entirety to reflect updates to the policies and procedures for making and processing warranty claims and defect reports.	22144	12-23-04
<b>Chapter 7, Disposal of Surplus Vehicles, Parts, and Equipment</b>				
7	Disposal of Surplus Postal Service–Owned Vehicles	revised in its entirety to reflect updates to the policies and procedures for disposing of surplus Postal Service-owned vehicles.	22106	7-10-03
7	Disposal of Surplus Postal Service–Owned Vehicles	renamed and revised in its entirety to reflect updates to the policies and procedures for disposing surplus vehicles, parts, and equipment.	22151	3-31-05
<b>Chapter 8, Lost/Stolen Vehicles</b>				
8	Lost/Stolen Vehicles	added to reflect policies and procedures for reporting lost/stolen Postal Service–owned vehicles.	22106	7-10-03
<b>Appendix C, Forms Glossary and Record Retention Schedule</b>				
Appendix C	Forms Glossary and Record Retention Schedule	revised to delete entries for PS Form 4585 and PS Form 4586.	22244	10-23-08

**Note:**

In the course of updating the online version of this handbook, we deleted Appendix E, “Exhibits,” because we listed the exhibits in the Contents.



## Fleet Management

Handbook PO-701

March 1991

### A. Material Transmitted

This replaces Handbook PO-701, *Fleet Management*, dated January 4, 1988.

### B. Explanation

This handbook defines management's responsibility for fleet management and prescribes procedures to attain maximum efficiency. It has been revised to update Chapters 1, 4, 5, and 7. Chapters 2, 3, and 6 remain unchanged except for minor corrections. They will be updated in a future revision.

### C. Initial Distribution

A copy of this handbook should be given to or ordered for persons in the following positions at offices with postal-owned, leased, or rural carrier vehicles:

- Postmaster
- Manager, Bulk Mail Facility
- Accountant, Postal Facility
- Manager, Personnel Services
- Operations Manager
- Manager, Delivery and Retail Programs
- Manager, Delivery and Collection
- Fleet Manager
- Superintendent, Vehicle Operations
- Manager, Stations and Branches
- Superintendent, Vehicle Maintenance
- Supervisor, Vehicle Maintenance
- Chief of Supplies
- Vehicle Operations Analyst
- Supervisor, Vehicle Dispatching
- Vehicle Operations Maintenance Assistant (VOMA)
- Delivery Services Program, W.F. Bolger Management Academy
- Other fleet personnel at postmaster's discretion

### D. Requisitions

Order any necessary additional copies from your material distribution center on Form 7380, *MDC Supply Requisition*.

**E. Issuances Rescinded**

This issue of Handbook PO-701 rescinds the January 4, 1988, issue and all previous issues of Handbook M-52.

**F. Comments and Questions**

1. Content.

Address any comments or questions regarding the content of this handbook to:

OFFICE OF FLEET MANAGEMENT  
USPS HEADQUARTERS RM 6670  
475 L ENFANT PLAZA SW  
WASHINGTON DC 20260-7240

2. Clarity.

Send any suggestions regarding the language or organization of this handbook to:

DOCUMENT CONTROL DIVISION  
USPS HEADQUARTERS RM 2800  
475 L ENFANT PLAZA SW  
WASHINGTON DC 20260-1571

**G. Effective Date**

This material is effective immediately.



*Arthur Porwick*  
*Assistant Postmaster General*  
*Operations Systems and Performance Department*

# Contents

<b>1</b>	<b>Introduction and Overview</b>	<b>1</b>
11	Purpose and Scope	1
111	Purpose	1
112	Scope	1
12	Responsibilities	1
121	Headquarters	1
122	Region	1
123	Field Division	1
124	Management Sectional Center (MSC)	2
125	Vehicle Post Offices	2
13	Fleet Management Organization	2
131	Vehicle Operations	2
132	Vehicle Maintenance	2
14	Fleet Management Programs	3
141	Model Vehicle Services Program	3
141.1	Objective	3
141.2	Scope	3
141.3	Model Certification	3
141.31	General	3
141.32	Fleet Management Advisory Council	3
141.33	Model I Certification	4
141.34	Model II Certification	4
141.35	Request for Certification	4
141.36	Request for Recertification	4
141.4	Model Vehicle Services Training, Testing and Evaluations	4
141.5	Transportation Subsystem Audit	4
141.51	Definition	4
141.52	Completion	4
141.6	Model Vehicle Operations Maintenance Assistant Program	5
142	Fleet Stratification Program	5
142.1	Definition	5
142.2	Objective	5
142.3	Long Life Vehicle	5
<b>2</b>	<b>Vehicle Operations and Utilization</b>	<b>9</b>
21	Overview	9
211	Objective	9

212	Mail Distribution and Equipment .....	9
212.1	Outgoing Distribution .....	9
212.2	Incoming Distribution .....	9
212.3	A.M. Dispatches .....	9
212.31	Coordination .....	9
212.32	Carrier Departure Time .....	9
212.4	Afternoon Trip/Evening Closeout .....	9
212.5	Empty Equipment .....	10
213	Routes of Travel .....	10
213.1	Establishment .....	10
213.2	Review .....	10
22	Vehicle Assignment, Scheduling, and Dispatching .....	10
221	Vehicle Assignment .....	10
221.1	General .....	10
221.11	Identifying Need .....	10
221.12	Responsibility .....	10
221.2	Repair and Replacement of Vehicles .....	11
221.21	Vehicles Requiring Extensive Repair .....	11
221.22	Surplus and Seized Vehicles .....	12
221.23	New Vehicles .....	13
221.24	Assignment of Older Vehicles .....	14
221.3	Vehicle Serial Numbers .....	14
221.31	Responsibility .....	14
221.32	Mail-Hauling Vehicle Numbers .....	14
221.33	Non-Mail-Hauling Vehicle Numbers .....	16
221.34	P-Tags and License Plates .....	17
221.4	Delivering Vehicles .....	17
221.41	Examination for Damage .....	17
221.42	Claims for In-Transit Damage .....	18
221.5	Vehicle Hire .....	19
221.51	Criteria .....	19
221.52	Specifications .....	20
221.53	Rates .....	20
221.54	Inspection .....	21
221.55	Identification .....	21
221.56	Maintenance and Other Contract Services .....	21
221.57	Temporary Contract Vehicle Hire .....	22
221.58	Emergency Vehicle Hire .....	22
221.6	Shipment and Transfer of Vehicles .....	22
221.61	National Shipments .....	22
221.62	Regional/Local Procurements .....	23

## Contents

221.63	Informal Transfer Procedures .....	23
221.64	Types of Transfers .....	23
222	Vehicle Scheduling .....	24
222.1	Responsibility .....	24
222.11	Mail Processing .....	24
222.12	Customer Services .....	24
222.13	Fleet Manager .....	24
222.2	Developing Schedules .....	25
222.21	Delivery Services Schedules .....	25
222.22	Intracity and/or Intercity Schedules .....	25
222.23	Service Point Summary .....	25
222.24	Filing Vehicle Schedules .....	25
222.25	Unscheduled Service .....	25
222.26	Relay Service .....	25
223	Vehicle Dispatching .....	29
223.1	Dispatch Point Operations .....	29
223.2	Citywide Operations .....	29
223.3	Time-Oriented Movement Control Systems (Optional) .....	29
223.31	Pegboard System .....	29
223.32	Magnetic Boards .....	32
223.4	Terminal Operations Control Boards (Mandatory) .....	32
223.5	Railroad Van Control .....	32
223.51	Visual Control .....	32
223.52	Form 4539, Railroad Van Movement Log .....	32
223.6	Two-Way Radio Control .....	34
223.7	Form 4572, Tractor Log .....	34
23	Vehicle Utilization Surveys .....	37
231	Purpose and Scope .....	37
232	Basic Surveys (Delivery Service Operations) .....	37
232.1	Definition .....	37
232.2	Procedures .....	37
232.3	Analysis .....	37
232.31	General .....	37
232.32	Specific Areas of Analysis .....	38
233	Secondary Surveys (Motor Vehicle Service Operations) .....	39
233.1	Definition .....	39
233.2	Procedures .....	39
233.3	Preparing Survey Forms .....	39
233.31	Form 4575, MVS Vehicle Survey .....	39
233.32	Form 4575-A, Five Day Summary—MVS Vehicle Utilization .....	41
233.33	Form 4572, Tractor Log .....	41

233.34	Form 4569, Vehicle Use Plan .....	41
233.4	Preparing Narrative Report .....	47
24	Driver and Supervisor Responsibilities .....	47
241	General .....	47
242	Passengers and Passenger Seats .....	47
242.1	Authorized Passengers .....	47
242.2	Passenger Seats .....	47
243	Emergency Warning Devices and Fire Extinguishers .....	47
243.1	General .....	47
243.2	Fire Extinguishers .....	48
243.21	Description .....	48
243.22	Installation .....	48
243.3	Four-Way Emergency Flashers .....	48
243.4	Accident Report Kits .....	49
244	Supervisor Responsibilities .....	49
244.1	General .....	49
244.11	Supervisors in Charge .....	49
244.12	Dispatch Point Supervisors .....	49
244.13	Vehicle Operations Analysts .....	49
244.2	Training Newly Assigned Drivers .....	49
244.21	General .....	49
244.22	Craft Orientation .....	50
244.23	Street Observation .....	50
244.24	Improvement and Refresher Driver Training .....	52
244.25	Safety Talks .....	52
244.3	Work Assignments and Schedules .....	52
245	Driver Responsibility .....	53
245.1	Care and Handling of Vehicles .....	53
245.11	General .....	53
245.12	Repair Tag .....	53
245.13	Form 4703, Out of Order (Trailer Tag) .....	53
245.2	Driving Practices .....	53
245.21	Speed Limit .....	53
245.22	Safety Check .....	54
245.23	Road Calls .....	54
245.24	Consistent Road Failures .....	54
245.25	Traffic Laws .....	54
245.26	Seat Belts .....	54
245.27	Parking and Securing Vehicle .....	54
245.28	Protection of Mail in Vehicles .....	56
245.3	Accident Procedures .....	56



## Contents

245.4	Form 4570, Vehicle Time Record .....	57
245.41	General .....	57
245.42	Completing Form 4570 .....	57
245.43	Frequency for Completing Form 4570 .....	57
245.44	Computing Form 4570 .....	57
245.45	Totalling Form 4570 .....	59
245.46	Automated Vehicle Time Recording Systems .....	59
246	Driver Awards and Contests .....	59
25	Guidelines for Using Contract or Postal Vehicle for Transportation Service .....	59
251	Types of Service To Be Compared .....	59
252	Cost Comparison Features .....	59
253	Frequency of Service Symbols .....	60
253.1	Frequency Symbols for Days of the Week .....	60
253.2	Frequency Symbols for Holidays and Exceptions .....	60
253.21	Service Symbols for Holidays Only .....	60
253.22	Symbols for Exceptional Service .....	60
253.3	Number and Sequence of Service Symbols .....	60
254	Perpetual Frequencies .....	62
254.1	To Compute Basic Rate Per Mile .....	62
254.2	To Compute Contract Service Payment .....	62
26	Motor Vehicle Accident Investigation .....	73
261	General .....	73
261.1	Scope .....	73
261.2	Responsibility .....	73
261.21	Postal Service .....	73
261.22	Postmasters and Installation Managers .....	73
261.23	Employee's Immediate Supervisor .....	73
262	Reporting Vehicle Accident Damage .....	74
262.1	Required Reporting .....	74
262.11	Postmaster or Installation Manager .....	74
262.12	VMF Manager .....	74
262.2	Review of PS Form 4564 .....	74
263	Claims for Private-Party Damage to Postal Service Vehicles .....	74
263.1	Preparing Claims .....	74
263.11	Threshold for Recovery .....	74
263.12	Estimating and Documenting Repairs and Replacement .....	75
263.13	Negotiating Settlements .....	76
263.2	Incomplete Collection .....	76
263.3	Acceptance of Payment .....	76
263.4	Adjustments to Claims .....	76
263.5	Compromise Settlements .....	76

263.6	Offers in Kind .....	77
264	Claims for Damage Involving Other Government Agency .....	77
265	Damage by Postal Employee .....	77
265.1	General .....	77
265.2	Request for Counsel .....	77
265.21	Employee Action .....	77
265.22	Management Action .....	77
266	Claim for Damage to Leased Vehicles .....	78
266.1	Contract Obligations .....	78
266.2	Liability Not Accepted .....	78
266.3	Contractor's Responsibility .....	78
266.31	Reporting Damage .....	78
266.32	Filing a Claim .....	78
266.4	Authority .....	79
266.5	Criteria for Adjudication of Claims .....	79
266.51	Judgment .....	79
266.52	Claims for Less Than \$50 .....	79
266.53	Claims for \$50 Through \$100 .....	79
266.54	Claims Over \$100 .....	79
266.55	Payment for Vehicles Being Repaired .....	79
266.56	Technical Advice .....	80
266.57	Processing Claims .....	80
267	Contractor's Mail Vans .....	80
267.1	Nature of Claims .....	80
267.2	Liability for Loss or Damage .....	81
267.21	Postal Service Responsibility .....	81
267.22	Contractor or Other Responsibility .....	81
267.3	Determining Responsibility for Damage .....	81
267.4	Report of Accident .....	81
267.5	Investigation by Fleet Manager .....	81
267.6	Action on Receipt of Claim .....	82
27	Cargo Loading and Control for Vehicle Movements of Mail Containers .....	82
271	General .....	82
272	Responsibility .....	82
273	Training and Equipment .....	83
273.1	Training .....	83
273.2	Equipment .....	83
274	Elements of Good Loading .....	83
274.1	Total Vehicle Time at the Dock .....	83
274.2	Proper Weight Distribution .....	83
274.3	Weight Limitation of Vehicle or Containers Being Loaded .....	83

## Contents

274.4	Securing Vehicle Loads	83
274.41	Shoring Bars	83
274.42	Rectangular Wire Mesh Containers	90
274.43	Combitainers	90
274.44	General Purpose Mail Container	90
274.45	Post-Con Container	90
274.5	Securing Tray Carts	90
275	Leveling Devices	92
276	Loading Diagrams	93
<b>3</b>	<b>Fleet Maintenance and Control</b>	<b>103</b>
31	Purpose, Objective, and Guidelines	103
311	Purpose	103
312	Objective	103
313	General Guidelines	103
32	Organizational Structure of Vehicle Maintenance Facilities	104
321	Functional Areas	104
322	Responsibility	104
322.1	Region	104
322.2	Field Division General Manager	104
322.3	MSC Manager	105
322.4	Headquarters	105
322.5	Fleet Manager	105
322.6	Shop Supervisor	105
323	Acquiring or Expanding VMFs	105
323.1	General	105
323.2	Considerations for Expansion	106
323.3	Planning Expansions	106
323.4	Establishing VMFs at Vehicle Post Offices	106
323.41	MSC Manager/Postmaster Responsibilities	106
323.42	Final Approval	106
33	Vehicle Post Offices Vehicles	106
331	General	106
332	VPO Vehicle Maintenance Schedules	107
332.1	Responsibility	107
332.2	Repairs Over \$250	107
34	Scheduled and Unscheduled Maintenance	107
341	Scheduled Maintenance	107
341.1	General Guidelines	107
341.2	The Maintenance Year	107

341.3	Maintenance Periods .....	108
341.31	Less Than 500 Miles .....	108
341.32	More Than 500 Miles .....	108
341.33	Less Than 2,000 Miles .....	108
341.34	More Than 2,000 Miles .....	108
341.35	Cycle Groups .....	108
341.4	Items Performed in Conjunction With Scheduled Maintenance .....	108
341.41	Polishing .....	108
341.42	Painting and Body Repair .....	108
341.43	Lubrication .....	109
341.44	Tire Inflation .....	109
341.45	Wear and Tear Conditions .....	109
342	Unscheduled Maintenance .....	109
342.1	Road Calls .....	109
342.2	Accident Repairs .....	109
342.3	Component Repairs .....	110
342.4	Testing New Products .....	110
343	Form 4513, Scheduled/Unscheduled Maintenance Record, and Form 4513-A, Scheduled/Unscheduled Shop Maintenance .....	110
343.1	Purpose .....	110
343.2	Fleet Manager Review .....	110
343.3	Handling Delays .....	110
343.4	Retention .....	110
344	Form 4543, Vehicle Maintenance Work Order .....	111
344.1	General .....	111
344.2	Preparation .....	111
344.3	Scheduled Maintenance .....	111
344.4	Unscheduled Maintenance .....	111
344.5	General Use of Form 4543 .....	111
35	Vehicle Modifications and Repairs .....	111
351	Types of Modifications and Repairs .....	111
351.1	Minor Changes and Repair Techniques .....	111
351.2	Modifications to Air Pollution Control Devices .....	112
351.3	Vehicle Modification Orders .....	112
351.4	Borrowed Vehicle Repairs .....	112
352	Recording Modification Parts and Labor .....	112
352.1	Parts and Materials .....	112
352.2	Labor .....	112
36	Safety Standards and Practices .....	113
361	General .....	113
361.1	Standards .....	113

## Contents

361.2	Ventilation .....	113
361.3	Housekeeping .....	113
361.4	Oil Additives .....	113
361.5	Face Masks and Respirators .....	113
362	Lifts and Hoists .....	113
363	Welding .....	114
364	Brakes .....	114
365	Tires .....	114
366	Flammable Liquids and Hazardous Waste .....	115
366.1	Flammable Liquids .....	115
366.11	General .....	115
366.12	Storing Flammable Liquids .....	115
366.13	Transporting Flammable Liquids .....	115
366.14	Disposing of Flammable Liquids .....	116
366.2	Hazardous Waste .....	116
366.21	Disposing of Hazardous Waste .....	116
366.22	Disposing of Flammable Waste .....	116
367	Tools .....	116
367.1	Grinders .....	116
367.2	Portable Electric Handtools and Equipment .....	116
368	Batteries .....	117
369	Safety Glass, Windshields, and Doors .....	117
37	Vehicle Fueling and Fuel Storage .....	117
371	Purchasing Mobile Bulk Fuel Truck Tankers .....	117
371.1	Authorization and Policy .....	117
371.2	Specifications and Requirements .....	117
371.21	Specifications .....	117
371.22	Requirements .....	117
371.3	Certification and Inspection .....	118
372	Fueling Bulk Mobile Truck/Tankers .....	118
372.1	From Supplier Depot .....	118
372.2	From Storage Tanks .....	118
373	Fueling Vehicles From Bulk Truck/Tankers .....	118
373.1	Fuel Type .....	118
373.2	Smoking .....	119
373.3	Positioning the Truck/Tankers .....	119
373.4	Wheel Chocking .....	119
373.5	Hoses and Nozzles .....	119
373.6	Recording Fuel Usage .....	119
373.7	Reporting Fuel Spills .....	119
373.8	Reporting Defects .....	119

374	Bulk Fuel Storage .....	120
375	Bulk Fuel and Oil .....	120
375.1	Purchasing Bulk Fuel and Oil .....	120
375.11	General .....	120
375.12	Service Stations and the Defense Logistics Agency .....	120
375.13	Commercial Credit Cards .....	120
375.14	GSA National Credit Cards .....	121
375.15	Credit Other Than Credit Card .....	121
375.16	Cash or No Fee Money Order .....	121
375.2	Processing Fuel Purchases .....	121
375.21	Postal-Owned Vehicles .....	121
375.22	Contract Vehicles .....	122
375.3	Fuel and Oil Inventory and Storage .....	122
375.4	Motor Fuel Pump Meters .....	123
375.41	Maintenance .....	123
375.42	Test Procedures .....	123
376	Minor Services .....	123
376.1	Selecting a Service Station Vendor .....	123
376.2	Vendor Selection Factors .....	123
376.21	Shuttling Costs .....	123
376.22	Hours of Operation .....	123
376.23	Under the Hood Service .....	123
376.24	Timeliness of Service .....	123
376.25	Emergency Service .....	124
38	Training Fuel Truck/Tanker Operators .....	124
381	General .....	124
382	Responsibility .....	124
382.1	Fleet Manager .....	124
382.2	Division .....	124
382.3	Trainee .....	124
383	Types of Training .....	125
383.1	Driver Instructor/Examiner .....	125
383.2	Local Training Programs .....	125
383.3	Safety Talks .....	125
384	Recording Training .....	125
385	Training Aids and Technical Publications .....	125
385.1	Training Aids .....	125
385.2	Technical Publications .....	125

<b>4</b>	<b>Vehicle Management Accounting System .....</b>	<b>127</b>
41	Overview .....	127
411	Definition .....	127
412	Objective .....	127
413	Types of Data .....	127
413.1	Management Data .....	127
413.2	Accounting Data .....	127
413.3	Shared Data .....	127
414	General Guidelines .....	128
42	VMAS Processes at VMFs .....	128
43	VMAS Microcomputer at VMFs .....	128
431	Physical Environment .....	128
431.1	Location .....	128
431.2	Temperature .....	128
432	General Operating Instructions .....	129
432.1	Hardware .....	129
432.2	Software .....	129
432.3	Data Transmission .....	129
44	VMAS Responsibilities: Managers, Vehicle Programs and Vehicle Services .....	129
441	Selecting Personnel .....	129
442	Reviewing Source (Input) Documents .....	129
442.1	Fleet Managers .....	129
442.2	Fleet Manager/Source Originator .....	130
442.3	Fleet Manager/Computer Operator .....	130
443	Reviewing Local Reports .....	130
443.1	Weekly Reviews .....	130
443.11	Work Order Reports .....	130
443.12	Employee Roster .....	130
443.2	Accounting Period Reviews .....	130
443.21	Vehicle Utilization Report .....	130
443.22	Vehicle Inventory Report .....	130
443.23	Fuel Tank Inventory Report .....	131
443.24	Parts Inventory Report .....	131
443.25	Parts Usage, Issue List, and Issue Audit Reports .....	131
443.3	Recurring Reviews .....	131
443.31	Parts Reorder Report .....	131
443.32	Parts Backorder Report .....	131
443.4	Transmission Reviews .....	131
443.41	Transmission Verification Report .....	131
443.42	Negative Transaction Report .....	131

443.5	Password Programs Report	131
444	Reviewing Postal Data Center Reports	131
444.1	Vehicle Maintenance Cost Report in Dollars	131
444.2	Vehicle Maintenance Payroll and Fringe Benefits Report	132
444.3	Bulk Fuel/Oil Inventory (By Tank Number/Facility) Report	132
444.31	General	132
444.32	Purchase Entries	132
444.33	Duplicate Entries	132
444.4	Assigned Location of Vehicles Report	132
444.5	Inventory Status VMAS Parts and Materials Report	132
444.51	General	132
444.52	Total Dollar Value	132
444.53	Account Identifier Codes	132
444.54	Discrepancies	133
444.6	Make/Model and Component Cost Report	133
444.7	Vehicle Utilization by Make/Model Report	133
444.8	Fuel and Oil Usage by Make/Model Report	133
444.9	VMAS Rejected Transaction List Report	133
445	Fleet Efficiency Indicators	133
445.1	General	133
445.2	Fleet Efficiency Indicators Derived From the Vehicle Maintenance Cost Report (in Dollars)	133
445.21	Ratio of Total Labor for Scheduled Maintenance to Direct Maintenance/Labor	133
445.22	Ratio of Total Labor Plus Contract for Scheduled Maintenance to Direct Maintenance Labor Plus Contract	133
445.23	Ratio of Undistributed Labor to Total Direct Labor	134
445.24	Ratio of Total Indirect Labor to Total Direct Labor	134
446	Retention of Microcomputer Reports	134
45	Vehicle Accounting Codes	136
451	Description	136
452	Direct Maintenance and Repairs	136
452.1	Account Code 22 — Scheduled Maintenance	136
452.2	Account Code 23 — Road Calls	136
452.3	Account Code 24 — Unscheduled Repairs	136
452.4	Account Code 25 — Accident Repairs	136
452.5	Account Code 26 — Component Rebuilding	137
452.6	Account Code 27 — Parts and Materials, Bulk Issues	137
452.7	Account Code 28 — Shuttle Time	137
452.8	Account Code 29 — Vandalism	137
453	Operating Supplies	137



## Contents

453.1	Account Code 31 — Gasoline, Bulk .....	137
453.2	Account Code 32 — Diesel Fuel, Bulk .....	137
453.3	Account Code 33 — Gasoline, Commercial .....	137
453.4	Account Code 34 — Diesel Fuel, Commercial .....	137
453.5	Account Code 35 — Engine Oil, Bulk .....	138
453.6	Account Code 36 — Engine Oil, Commercial .....	138
453.7	Account Code 37 — Tires and Tubes .....	138
454	Fleet Servicing .....	138
454.1	Account Code 30 — Fleet Servicing .....	138
454.2	Account Code 39 — Washing Vehicles .....	138
454.3	Account Code 39 — Fueling Vehicles .....	138
455	Work Chargeable to Others .....	138
455.1	Account Code 42 — Maintenance and Repair Chargeable to Others (Except Warranty) .....	138
455.2	Account Code 43 — Reimbursable Operating Supplies .....	138
455.3	Account Code 44 — Revenues From Reimbursement .....	138
455.4	Account Code 41 — Reimbursable Contractual Services .....	139
456	Warranty .....	139
456.1	Account Code 45 — Warranty Repairs .....	139
456.2	Account Code 46 — Warranty Revenues .....	139
457	Depreciation .....	139
457.1	Account Code 50 — Depreciation of Vehicles .....	139
457.2	Account Code 51 — Vehicle Sales Expenses .....	139
457.3	Account Code 52 — Gain or Loss on Sale of Vehicles .....	139
458	Distributed Overhead .....	139
458.1	Personnel .....	139
458.11	Account Code 61 — Supervisory Time Costs .....	139
458.12	Account Code 62 — Stockroom .....	139
458.13	Account Code 63 — Clerks .....	139
458.2	Overhead .....	140
458.21	Account Code 64 — Repairs to Shop Equipment .....	140
458.22	Account Code 65 — Garage Maintenance .....	140
458.23	Account Code 66 — Training .....	140
458.24	Account Code 67 — Undistributed Labor .....	140
458.25	Account Code 68 — Rent and/or Depreciation of Buildings .....	140
458.26	Account Code 69 — Depreciation: Garage Equipment, Furniture, and Fixtures .....	140
458.27	Account Code 71 — Travel .....	140
458.28	Account Code 72 — Fuel, Utilities, and Communications .....	140
458.29	Account Code 73 — Cannibalization of Vehicles: Vehicle Sales Expenses (Outside) .....	141

459	Expenses Other Than Vehicle Maintenance .....	141
459.1	Account Code 91 — Maintenance and Repair of Postal-Owned Equipment .....	141
459.2	Account Code 92 — Evaluation, Experimentation, and Modification .....	141
459.3	Account Code 93 — Paid Leave Variance .....	141
46	Account Identifier Codes .....	142
461	Definition .....	142
462	Receipt AICs .....	142
462.1	Trust Funds Received — AIC 080 .....	142
462.2	Sale of Vehicle Supplies and Services — AIC 151 .....	142
462.3	Reimbursement for Damages to Vehicles — AIC 162 .....	142
463	Disbursement AICs .....	142
463.1	Postal Supplies and Services .....	142
463.11	Postal Supplies (VMF) — AIC 550 .....	142
463.12	Postal Services (VMF) — AIC 584 .....	143
463.13	Fee for Services, Postal Operations — AIC 587 .....	143
463.14	Equipment Rental (VMF) — AIC 613 .....	143
463.2	Vehicle Supplies and Services .....	143
463.21	Vehicle Supplies Expensed — AIC 594 .....	143
463.22	Vehicle Sales Expenses: Advertising Sale — AIC 595 .....	143
463.23	Vehicle Service and Maintenance — AIC 604 .....	143
463.24	Vehicle Repair Parts and Materials — AIC 614 .....	143
463.3	Utilities .....	144
463.31	Electricity (VMF) — AIC 555 .....	144
463.32	Oil Heating — AIC 565 .....	144
463.33	Gas Heating — AIC 570 .....	144
463.34	Other Heating — AIC 580 .....	144
463.35	Water — AIC 575 .....	144
463.36	Sewage, Garbage, and Other Disposal — AIC 582 .....	144
463.4	Travel and Training .....	144
463.41	Travel for Training (Inside USPS) — AIC 646 .....	144
463.42	Travel for Training (Outside USPS) — AIC 683 .....	144
463.43	463.43 Training Instructor Fees (VMF) — AIC 686 .....	144
463.44	Training Supplies and Materials (VMF) — AIC 687 .....	144
463.5	Communications .....	145
463.51	Telephone (VMF) — AIC 560 .....	145
463.52	TWX, ARS, and Other Telegraphic Expenses (VMF) — AIC 618 .....	145
463.6	Trust Funds Withdrawn — AIC 480 .....	145
463.7	Tolls and Ferriage — AIC 540 .....	145
463.8	Energy and Safety Projects (VMF) .....	145
463.81	Energy Projects Expenses — AIC 620 .....	145
463.82	Safety Projects Expenses — AIC 629 .....	145

## Contents

47	FEDSTRIP Definitions and Funding Codes for VMF Use	146
471	Definition	146
472	Custodial Supplies—Fund Code “2”	146
472.1	Cleaning Supplies	146
472.2	Washroom Supplies	146
472.3	Other Supplies	146
473	Postal Supplies—Fund Code “5”	146
473.1	Office Supplies	146
473.2	Packing Supplies	146
473.3	Photography Supplies	146
473.4	Paper Supplies	146
473.5	Tray Supplies	147
473.6	Protective Clothing Supplies	147
473.7	Miscellaneous Supplies	147
474	Parts for Inventory — Fund Code “S”	147
475	Quick Reference Guide for VMF Revenues and Disbursements	147
<b>5</b>	<b>Stockroom Management</b>	<b>149</b>
51	Overview	149
511	Purpose	149
512	Responsibility	149
513	General Guidelines	149
52	Types of Supply Items	149
521	Motor Vehicle Parts and Supplies	149
521.1	Supply Sources	149
521.2	Ordering Instructions	150
521.3	Local Purchase	150
522	Exchange Assemblies and Rebuilds	150
522.1	Supply Sources	150
522.11	Local Contracts	150
522.12	Basic Pricing Agreements	150
522.2	Ordering Instructions	150
523	Cannibalization	151
524	FEDSTRIP Supplies	151
525	General, Office, and Medical Supplies	151
53	Physical Arrangement and Storage of Supply Items	151
531	Physical Arrangement	151
532	Low Cost Bulk Items	152
532.1	Definition	152
532.2	Physical Arrangement of Low Cost Items	152

532.21	Open Receptacles .....	152
532.22	Within Stockroom Enclosure .....	152
532.3	Recording Low Cost Items .....	153
54	Stockroom Maintenance and Control .....	153
541	General .....	153
541.1	Existing Stock .....	153
541.2	New Inventory Items .....	153
541.3	Adjusting Stock Levels .....	153
542	Stockroom Procedures .....	153
542.1	Recording Part Numbers .....	153
542.2	Recording Additions (Microcomputer) .....	153
542.3	Determining Inventory Unit Price .....	154
542.31	General .....	154
542.32	Outside Commercial Rebuilding of Inventory Items .....	154
542.33	Inventory Items Obtained at No Cost .....	154
542.34	One-Time Purchase Inventory Items .....	154
542.4	Recording Issuances (Microcomputer) .....	154
542.41	Microcomputer and Work Order Entries .....	154
542.42	VPO Stock Entries .....	155
542.5	Recording Returned Items .....	155
542.51	To Stock .....	155
542.52	To Materiel Distribution Centers .....	155
542.53	To Vendors .....	155
542.6	Reporting Interchangeable Parts .....	155
542.7	Exchanging Obsolete Parts .....	155
542.8	Returning Defective or Substandard Parts .....	157
55	Stockroom Inventories .....	157
551	General .....	157
551.1	Stock Levels .....	157
551.2	Mounted Tires and Batteries .....	157
552	Responsibility .....	157
552.1	VMF Supervisor .....	157
552.2	Fleet Manager and Stockroom Personnel .....	158
553	Interim Inventories .....	158
554	Analyzing Inventory Differences .....	158
555	Reporting Inventories to the PDC .....	158
555.1	General .....	158
555.2	Preparing the Report .....	158
555.3	Mailing the Report .....	158
555.4	Mailing Copies of the Report .....	159
56	VMF Equipment and Tools .....	159

## Contents

561	General	159
562	Stockroom Responsibility	159
562.1	Managers, Vehicle Programs and Vehicle Services	159
562.2	Tour Supervisors	159
562.3	Stockroom Personnel	159
563	Tool Kits — Automotive Mechanic Handtools	159
563.1	Assigning Tool Kits	159
563.2	Issuing Tool Kits	159
563.3	Liability for Tool Kits	160
563.4	Commingling of Tool Kits	160
563.5	Replacing or Adding to Tool Kits	160
564	Tool Inventory	160
564.1	Complete Tool Kits	160
564.2	Individual Tool Replacements	160
564.3	Additions to Tool Kit	161
564.4	Verifying Tools On Hand	161
57	Equipment Maintenance	161
571	Establishing a Maintenance Schedule	161
572	Annual Equipment Inspection	161
572.1	Examination	161
572.2	Cleaning and Repairs	161
572.3	Electrical Equipment	161
572.4	Painting	161
572.5	Contract Repairs	161
572.6	Leased Facility Repairs	162
573	Surplus Equipment	162
574	Service and Repair Equipment	162
575	Test Equipment	162
576	Safety Equipment	162
577	Body Shop Equipment	162
<b>6</b>	<b>Warranty Claims and Defect Reports</b>	<b>187</b>
61	General	187
611	Warranty Recovery Program	187
612	Warranty Information	187
613	Warranty Labor Recovery Rate	187
62	Options and Methods for Warranty Repair and Recovery	188
621	Repair by a Dealership or Commercial Repair Facility	188
622	Repair and Recovery by a VMF	188
623	Repair by VMF, With Commercial Recovery Service	189

624	Replacement Parts From Stock .....	189
625	Warranty Parts for Vehicles Out of Warranty .....	189
63	Refusal or Delay of Warranty Service .....	190
64	Reporting Vehicle Defects or Deficiencies .....	190
641	Routine Defects .....	190
642	Urgent Defects .....	190
65	Adjustments, Repairs, and Defects Not Covered by Warranty .....	191
651	Adjustments and Repairs .....	191
652	Defects .....	191
<b>7</b>	<b>Disposal of Surplus Vehicles, Parts, and Equipment .....</b>	<b>193</b>
71	Purpose .....	193
72	Scope .....	193
73	Responsibility .....	193
731	Headquarters Vehicle Operations .....	193
732	Philadelphia Vehicles Category Management Center .....	194
733	District Manager .....	194
734	Manager of Vehicle Maintenance .....	194
735	Managers/Postmasters .....	195
74	Policy .....	195
741	Excess Vehicles .....	195
742	Criteria for Disposal .....	195
743	Vehicle Storage .....	195
75	Preliminary Vehicle Disposal Procedures .....	195
751	Prior Approval .....	195
752	Removal of Mail, Mail-Related Equipment, and Postal Service Decals, Markings, and License Plates .....	196
752.1	Removal of Mail and Mail-Related Equipment .....	196
752.2	Removal of Postal Service Decals, Markings, and License Plates .....	196
753	Safety Inspections and Emissions Inspections .....	196
753.1	Safety Inspections .....	196
753.2	Emissions Inspections .....	196
754	Cleaning, Body Work, Painting, and Repairs .....	197
755	Warranty and Purchaser's Responsibility .....	197
756	Planning .....	197
757	Sales of Related Surplus Items .....	197
76	Vehicle Disposal Methods .....	198
761	General .....	198
762	Sales Restrictions .....	198
762.1	Right-Hand-Drive (RHD) Vehicles .....	198
762.11	Quarter-Ton Postal Service Jeeps .....	198

Contents

762.12	Other RHD Vehicles	199
762.2	Postal Service Personnel	201
763	Vehicle Sales	201
763.1	eBay Online Auction Sale	201
763.11	Vehicles CMC Responsibilities	201
763.12	MVM Responsibilities	201
763.2	Fixed-Price Sale	203
763.3	Live Auction Sale	203
764	Vehicle Cannibalization/Scrap	204
765	Authorized Donation	205
765.1	General	205
765.2	Museums (Static Display)	205
765.3	Law Enforcement Agencies	205
765.4	Foreign Postal Administrations	205
765.5	Other Requests	206
766	Receipt and Processing of Payment and Release of Vehicle	206
77	Required Forms and Approvals for Vehicle Disposal	207
771	PS Form 4587	207
772	PS Form 4594	207
773	PS Form 4595	208
774	Standard Form 97 (SF 97)	208
<b>8</b>	<b>Lost/Stolen Vehicles</b>	<b>209</b>
	<b>Appendix A — Acronyms and Abbreviations</b>	<b>211</b>
	<b>Appendix B — Directive References</b>	<b>213</b>
	<b>Appendix C — Forms Glossary and Record Retention Schedule</b>	<b>215</b>
	<b>Appendix D — Microcomputer Reports Retention Schedule</b>	<b>219</b>

# Exhibits

Exhibit 142.3 Characteristics of the Long Life Vehicle .....	6
Exhibit 221.211 Service Life and Maintenance Reinvestment Guidelines .....	11
Exhibit 221.322 Mail-Hauling Vehicle Numbers .....	15
Exhibit 221.33 Non-Mail-Hauling Vehicle Numbers .....	16
Exhibit 222.13c U.S. Postal Service MVS Master Vehicle Schedule Summary .....	24
Exhibit 222.22 Form 4533, MVS Schedule .....	26
Exhibit 222.23 MVS Service Point Summary .....	28
Exhibit 223.2 Sample Visual Control Panel .....	30
Exhibit 223.31 Optional Control Boards .....	31
Exhibit 223.4 Mandatory Control Boards .....	33
Exhibit 223.51 Tagboard-Assignment Schedule .....	34
Exhibit 223.7 Form 4572, Tractor Log .....	35
Exhibit 233.31 Form 4575, MVS Vehicle Survey .....	40
Exhibit 233.32 Form 4575-A Five Day Summary—MVS Vehicle Utilization .....	42
Exhibit 233.34 Form 4569, Vehicle Use Plan .....	44
Exhibit 244.232 Street Supervision Cost Comparison .....	51
Exhibit 245.22 Notice 76 and Label 70 .....	55
Exhibit 253.21 Service Symbols for Holidays Only .....	61
Exhibit 254.1 Perpetual Frequencies .....	63



Exhibits

Exhibit 274.2  
Proper Weight Distribution and Securing Vehicle Loads ..... 84

Exhibit 274.3  
Weight Limitations ..... 85

Exhibit 274.5a  
Secured Tray Carts ..... 91

Exhibit 274.5b  
Straps Not in Use ..... 91

Exhibit 275b  
Horizontal Vertical Lift (Scissors) ..... 92

Exhibit 275d  
Three Views of Permanent Docboard ..... 92

Exhibit 276a  
Hamper Loading ..... 93

Exhibit 276b  
Tray Cart Loading ..... 94

Exhibit 276c  
Postal-Pak Loading on Postal Vehicles ..... 95

Exhibit 276d  
Roller Conveyers ..... 96

Exhibit 276e  
Airlift "Igloo" ..... 96

Exhibit 276f  
Shoring Bar Sockets and Beam ..... 97

Exhibit 276g  
Horizontal A- or E-Track ..... 97

Exhibit 276h  
Heavy Duty Vertical E-Track ..... 98

Exhibit 276i  
Installing Shoring Bar in Horizontal A- or E-Track ..... 98

Exhibit 276j  
Installing Nylon Belting on A- or E-Track ..... 99

Exhibit 276k  
Leather Boot ..... 99

Exhibit 276l  
Ratchet Action Buckle ..... 100

Exhibit 276m  
Care of Ratchet Action Buckle ..... 101

Exhibit 446  
Retention of Microcomputer Reports ..... 135

Exhibit 475  
Quick Reference Guide for VMF Expenditures and Reimbursements ..... 148

Exhibit 542.6  
Parts Interchange/Parts Savings Notice ..... 156

Exhibit 574  
Service and Repair Equipment ..... 163

Exhibit 575  
Test Equipment ..... 179

Exhibit 576  
Safety Equipment ..... 181

Exhibit 577  
Body Shop Equipment ..... 183

Exhibit 762.11  
Vehicle Disposal Agreement ..... 200

# 1 Introduction and Overview

## 11 Purpose and Scope

---

### 111 Purpose

The purpose of this handbook is to provide the information necessary to support an aggressive, yet operationally efficient, fleet management program.

### 112 Scope

These guidelines and instructions cover the entire scope of vehicle services, including material handling and containerization methods, vehicle maintenance, tort claim accident investigations, processing, and adjudication, procurement procedures (including vehicle leasing), vehicle accounting, inventory control, and transportation of mail by postal-owned and leased vehicles.

## 12 Responsibilities

---

### 121 Headquarters

The Operations Systems and Performance Department (OSPD) is responsible for vehicle operations and maintenance. The Office of Fleet Management, OSPD, provides administrative support and technical guidance for operations and maintenance through the appropriate channels at the region and field division level.

### 122 Region

Designated personnel within the operations support function monitor the fleet management function.

### 123 Field Division

The person assigned to the field division position of manager, Vehicle Programs, has line responsibility for the fleet management function at the field division post office. This person provides functional guidance to field

vehicle maintenance facilities (VMFs) within the field division to ensure compliance with Headquarters policies and procedures. These duties include but are not limited to the following:

- a. Establishing new vehicle service.
- b. Overseeing workhour and equipment budgets.
- c. Validating staffing requirements for vehicle-related positions.
- d. Overseeing the tort claim accident investigation program.
- e. Conducting the vehicle sales program.
- f. Ensuring that preventative maintenance programs are followed.

#### 124 **Management Sectional Center (MSC)**

In an MSC having a vehicle maintenance facility and/or motor vehicle service, MSC manager/postmasters are responsible for the safe, efficient, and economical maintenance and operation of vehicles under their jurisdiction. The manager, Vehicle Services, has responsibility for both fleet operations and maintenance.

#### 125 **Vehicle Post Offices**

The postmaster is responsible for the safe, efficient, and economical maintenance and operation of assigned vehicles.

## 13 **Fleet Management Organization**

---

#### 131 **Vehicle Operations**

Vehicle operations is a vital element of the mailhandling activity. Vehicles are procured to move large volumes of mail between facilities or in-city delivery and also for certain service activities (i.e., firm pickup and delivery, plant loads, and collections). Vehicle operations provides safe, efficient, and economical use of postal-owned and leased vehicles. The vehicle operations program encompasses local transport operations, processing of new vehicle requirements, leased vehicle administration, vehicle assignment, delivery and mail processing transportation requirements, labor relations, tort claim accident investigation and local adjudication, street supervision, safety, dock and maneuvering area design, traffic flow, container operations, and vehicle sales. Vehicle operations supervisors must work closely with delivery and mail processing supervisors to optimize the use of all vehicles.

#### 132 **Vehicle Maintenance**

Vehicles are serviced and repaired in approximately 225 USPS vehicle maintenance facilities (VMFs) and in a great many commercial garages throughout the country. Vehicles are kept in safe, operable, and clean condition for use in the most economically feasible manner and in compliance with established standards and requirements. Vehicle maintenance

encompasses selecting and training mechanics, providing garages, tools, and equipment, and monitoring and maintaining preventive maintenance standards. Related to this effort is the preparation of specifications for vehicles, quality control, and pilot model testing of new vehicles, purchasing and inventorying parts, tires, fuel, oil, and greases, performing alternate fuel testing, handling hazardous materials, performing vehicle modifications, and administering the vehicle warranty program.

## 14 Fleet Management Programs

---

### 141 Model Vehicle Services Program

#### 141.1 Objective

The objective of the model vehicle services program is to implement and maintain uniform policies and procedures for vehicle services operations and to maximize efficiency by identifying and correcting service deficiencies.

#### 141.2 Scope

The Model Vehicle Services Program encompasses both vehicle operations and vehicle maintenance.

#### 141.3 Model Certification

##### 141.31 General

The model vehicle services program has two levels of certification which encompasses both vehicle operations and vehicle maintenance. The highest level of certification is the Model I office, with the next level being the Model II. Certification at both levels is valid for a period of three years. The underlying purpose of the certification program is to measure uniform and consistent compliance with current operating instructions and regulations and to ensure that VMFs are operating safely, efficiently, and effectively.

##### 141.32 Fleet Management Advisory Council

The Fleet Management Advisory Council has overall responsibility for the model vehicle services certification program. In addition to recommending model vehicle services policy to the Office of Fleet Management, the mission of the council is to develop programs that improve productivity and reduce costs. The council serves as a communication network for field input and provides a forum for an effective interchange of ideas. The council creates work and task groups to study problems from the field or OFM and recommends solutions. The council has 16 members, as follows, who serve three-year terms:

- a. Headquarters program manager.
- b. Staff person from each regional office.

- c. Two field division vehicle program managers from each region. These managers are selected from model vehicle service units by the council with the concurrence of Headquarters and respective regional offices.

#### 141.33 **Model I Certification**

This designation is awarded to those units that have already received the Model II designation and have achieved and maintained an efficiency rating of not less than 95 percent for a minimum of three consecutive quarters. The Model I designation requires on-site inspection and approval by a Fleet Management Advisory Council review team.

#### 141.34 **Model II Certification**

This designation is awarded to those units that achieve and maintain a minimum rating of 85 percent for a period of three consecutive quarters. The Model II certification also requires on-site inspection and approval by a Fleet Management Advisory Council review team.

**Note:** Auxiliary VMFs may qualify for either Model I or Model II certification.

#### 141.35 **Request for Certification**

Field divisions must request a review by the Fleet Management Advisory Council for certification as Model I or II, with a copy of the request to the Office of Fleet Management at Headquarters. The council will appoint a review team, and the team report will be sent to OFM.

#### 141.36 **Request for Recertification**

The Model I and Model II recertification requires a written request by the field division and on-site review by a Fleet Management Advisory Council review team.

#### 141.4 **Model Vehicle Services Training, Testing and Evaluations**

Model offices may be used to train employees, test new products, or evaluate state-of-the-art technologies.

#### 141.5 **Transportation Subsystem Audit**

##### 141.51 **Definition**

The Transportation Subsystem Audit is an integral part of the Model Vehicle Services and the Customer Services Improvement Process (CSIP) programs. The audit is a key tool for determining the efficiency of a unit at any given time and to identify areas that require corrective action.

##### 141.52 **Completion**

- 141.521 The Transportation Subsystem Audit is performed in each vehicle service and auxiliary service unit on a quarterly basis. The unit being audited must retain the completed audits for two years.

- 141.522 The MFO is responsible for answering the audit questions and for taking corrective action for those questions that are answered “No.”
- 141.523 In cases when a particular question is not applicable, the MFO must answer “N/A” (not applicable) and explain why the question is not applicable.

#### 141.6 **Model Vehicle Operations Maintenance Assistant Program**

The Model Vehicle Operations Maintenance Assistant (VOMA) Program is an extension of the Model Vehicle Services Program. The MFO or designee from the parent VMF conducts the certification audits. Recertification of Model VOMA operations must be made at least once each fiscal year. The MFO must conduct the audit in a positive manner with no exceptions and must provide whatever assistance is necessary for a unit to become a model unit.

### 142 **Fleet Stratification Program**

#### 142.1 **Definition**

Fleet stratification is a Headquarters program designed to reduce vehicle classes into four distinct groups:

- a. Light Delivery.
- b. Intermediate Delivery.
- c. Cargo Vans.
- d. Tractor-trailer Units.

#### 142.2 **Objective**

The objective of fleet stratification is to improve operational benefits and reduce maintenance costs.

#### 142.3 **Long Life Vehicle**

The backbone of the fleet stratification program is the Long Life Vehicle (LLV). See Exhibit 142.3. The LLV will replace the entire 1/4-ton and 1/2-ton delivery fleet. This replacement requires approximately six years and demands special attention from all levels of delivery management. The planned benefits include increased cubic capacity, improved mail security, improved driver comfort, increased fuel economy, and lower maintenance costs. The operational success of the LLV is the responsibility of all division/MSD managers. As the LLV is delivered, deployment based on local operational requirements will provide the greatest benefits. The operational goal of division/MSD managers is to reduce the total number of delivery vehicles assigned to an office. Division/MSD managers must make every effort to use the LLV to its greatest operational capacity.

Exhibit 142.3 (p. 1)

**Characteristics of the Long Life Vehicle**

Fleet size has been increasing annually, and this is reflected in an increase in fleet cost. A reduction or halting of this growth will be necessary to contain rising costs. Every effort must be made to use the long life vehicle to its greatest operational benefits.

The new postal van at a glance:



Dimensions:	Inches
Overall Length	175.5
Width	79.25
Height	85.00
Wheel Base	100.5
Weight	3,008 lbs.
Cargo Capacity	1,000 lbs. (108 cu. ft.)
Engine:	
Type	4 cylinder, in line, gasoline
Displacement	2.5 liters
Fuel system	Throttle Body Injection



Exhibit 142.3 (p. 2)

**Characteristics of the Long Life Vehicle****Our New Long-life Vehicle Will Have the Following Features — All Standard.**

**Chassis and Body:** Automatic transmission, 3-speed; rear wheel drive; limited slip differential; aluminum body; corrosion resistant, steel frames; right-hand drive; power steering; tires, Lt 195/75R14; turning circle, curb to curb — 34.6 feet.

**Fuel Economy:** EPA Combined Rating — 21.6.

**Mechanical:** 4-cylinder fuel-injected engine; right-hand drive; automatic transmission; power-assisted heavy duty, front-wheel disc brakes; power steering; 12-volt maintenance-free battery; double-A arm coil spring-front suspension; all weather light truck, steel-belted tubeless radial tires.

**Exterior:** Tinted safety glass windshield; 2-speed windshield wipers with blade-mounted windshield washers.

**Comfort:** Bi-level power air-flow ventilation with dash-mounted air deflectors; heater/defroster with two-speed electric blower; seat for driver that swivels for easy ingress/egress and access to rear cargo compartment; nylon woven-cloth fabric upholstery; interior sound level that will not exceed limits for passenger vehicle.

**Safety: Crashworthiness** at 35 mph; molded or impact-absorbing bumper that can withstand collision at 5 mph; collapsible steering column; safety belts for driver and passenger with automatic locking-type retracting reel.

**Capacity:** 108 cu. ft. cargo area with A-Track for securing containers with belts or bars (compares with 40 cu. ft. area in quarter-ton; 130 cu. ft. area in half-ton; half-ton cargo load).

**Special Features:** Working shelf that accepts three letter trays; easily installed passenger seat for training, route-sharing purposes; solid partition behind driver/passenger area with built-in lockable sliding door for access to cargo area.

**Other:** Minimum fuel capacity of 12 gallons; turning diameter that does not exceed 40 feet.

This page intentionally left blank

# 2 Vehicle Operations and Utilization

## 21 Overview

---

### 211 Objective

The objective of effective vehicle operations is to provide efficient mail movement that meets delivery requirements at the lowest cost possible.

### 212 Mail Distribution and Equipment

#### 212.1 Outgoing Distribution

Develop and coordinate outgoing dispatch schedules to correspond with mail processing distribution requirements.

#### 212.2 Incoming Distribution

Since incoming distribution must be coordinated with sources of supply (rail, air, HCR, and so forth), vehicle operations supervisors must be aware of distribution requirements.

#### 212.3 A.M. Dispatches

##### 212.31 Coordination

Coordinate station dispatches with managers, distribution, and stations and branches to enhance the flow of mail from distribution to delivery. When necessary, provide motor vehicle operators with keys for stations scheduled to receive mail prior to opening.

##### 212.32 Carrier Departure Time

Review final A.M. dispatches to determine if they correspond properly with carrier departure times.

#### 212.4 Afternoon Trip/Evening Closeout

Coordinate the afternoon drop with the carriers' return time to the stations/branches. This will provide for early processing of mails collected by the carriers. Coordinate the close out trip with the delivery units to avoid possible delay of MVS drivers and with mail processing to ensure that volumes collected will meet principal dispatches.

### 212.5 **Empty Equipment**

Collect and return empty containers to the mail processing facility to ensure that adequate equipment is available for loading at the mail processing facility. This procedure also eliminates dock congestion. Include activity on Form 4533, *MVS Schedule*, with appropriate allowable time.

### 213 **Routes of Travel**

#### 213.1 **Establishment**

Establish routes of travel serving regular runs from information provided on Form 4533. Print a route of travel for each run. Ensure that this route of travel is followed except when local traffic conditions dictate a more efficient alternative. In the case of deviations due to major road construction expected to be of long duration, issue an amended route of travel. Dispatchers may verbally approve detours of short duration.

#### 213.2 **Review**

Review all routes of travel to ensure best possible routing as part of the annual vehicle utilization surveys. Review and evaluate the opening of new expressways, highways, or bridges to determine if they can be incorporated into present route schedules. The use of tollways in some areas may prove to be economically advantageous. Arrangements may be made with tollway officials for annual passes, or funds may be provided to vehicle operators on a daily basis.

## **22 Vehicle Assignment, Scheduling, and Dispatching**

### 221 **Vehicle Assignment**

#### 221.1 **General**

##### 221.11 **Identifying Need**

Vehicle service may be established where city delivery service has been authorized. City delivery supervisors will develop the requirements for vehicle use in the collection and delivery functions.

##### 221.12 **Responsibility**

The assignment, transfer, and reassignment of vehicles, either postal-owned or leased, is the responsibility of designated personnel at the division. Base assignments on the following criteria:

- a. Service required for functional vehicles.
- b. Potential reduction of driver hours.
- c. Potential increase in vehicle utilization.
- d. Cost of vehicle operations.

221.2 **Repair and Replacement of Vehicles**

221.21 **Vehicles Requiring Extensive Repair**

Due to cumulative age and wear or extensive body damage, some vehicles might require considerable maintenance investment before being restored to operational service. Before authorizing extensive repairs, the district's manager of vehicle maintenance (MVM) must confirm with the functional customer that the vehicle is essential to operations. Additionally, the MVM must determine if the vehicle can be replaced with an existing surplus vehicle, or if it can be replaced more economically with a rented or leased vehicle until a permanent replacement is identified or acquired.

221.211 **Scheduled Service Life and Maintenance Reinvestment**

Before initiating any extensive vehicle repair, including a repair for major fire or body damage, vehicle maintenance facilities (VMFs) must assess maintenance reinvestment using PS Form 4587, *Request to Repair, Replace, or Dispose of Postal-Owned Vehicle*, in conjunction with [Exhibit 221.211](#). The MVM and the district manager (DM) or the DM's designee (excluding vehicle maintenance employees) must concur on any decision to exceed the maintenance reinvestment guidelines in Exhibit 221.211.

Exhibit 221.211

**Service Life and Maintenance Reinvestment Guidelines**

Vehicle Type	Life (Years)	Mileage (000)		Maintenance Reinvestment Threshold as Percentage of Vehicle Contract Price According to Age in Years											
		Total	Annual	1	2	3	4	5	6	7	8	9	10	11	12
<b>Light Delivery</b>															
LLV, FFV*	24	120	5	50	46	43	40	37	34	31	28	26	24	22	20
1/2-ton**	8	56	7	50	45	40	35	30	25	20	15	10	5	0	0
<b>Intermediate</b>															
1-ton	12	120	10	50	47	44	40	37	34	30	27	24	20	17	15
1-ton gasoline	12	120	10	50	45	40	35	30	25	20	15	10	5	5	5
2-ton	12	120	10	50	47	44	40	37	34	30	27	24	20	17	15
<b>Cargo Van</b>															
5-, 7-, 9-, & 11-ton	8	240	30	50	47	44	40	37	33	29	24	19	12	9	5
<b>Tractor</b>															
Single-Axle	8	360	45	50	45	40	35	30	25	20	15	10	5	0	0
Tandem-Axle	8	360	45	50	45	40	35	30	25	20	15	10	5	0	0
<b>Spotter</b>	8	NA	NA	50	45	40	35	30	25	20	15	10	5	0	0
<b>Trailer</b>	12	NA	NA	50	47	44	40	37	33	29	24	19	12	9	5
<b>Service Trucks</b>															
VMF	8	72	9	50	45	40	35	30	25	20	15	10	5	0	0
Plant Maint.	8	72	9	50	45	40	35	30	25	20	15	10	5	0	0
<b>Administrative</b>	8	72	9	50	40	30	20	5	0	0	0	0	0	0	0

\* Note: Original LLV service life expectancy was based on an aluminum body and a planned mid-life refurbishment program. Life expectancy for aluminum-bodied right-hand drive vehicles (LLVs and FFVs) is now 24 years, with ongoing maintenance of individual vehicles (including engine and transmission replacement) on an as-needed basis. For years 13–24, the threshold for maintenance reinvestment requiring completion of PS Form 4587 remains at 20 percent.

\*\* Includes Ford Windstar, Ford Aerostar, and Chrysler van-type vehicles acquired for delivery operations.

221.212 **Retain Records Permanently**

Permanently retain each individual work order for any engine, transmission, hour meter, or speedometer head replacement in the vehicle's maintenance file.

221.22 **Surplus and Seized Vehicles**

221.221 **Use of Available Surplus Vehicles Required**

VMFs must meet vehicle needs with existing Postal Service-owned vehicles whenever possible, documenting each vehicle requirement on PS Form 4515, *Vehicle Request, Review, and Approval*. Using PS Form 4515, the MVM will determine if surplus vehicles are available within the cluster. If surplus vehicles are not available, the MVM will contact the area vehicle maintenance programs analyst (VMPA), who will attempt to locate suitable vehicles in other performance clusters within the area. If no suitable vehicles are available, the VMPA will contact Headquarters Delivery Vehicle Operations (DVO), which may meet service needs by directing inter-area vehicle transfers or releasing storage vehicles. VMF personnel must thoroughly inspect vehicles released from storage and ensure that appearance deficiencies and all safety-related defects are corrected before the vehicle is returned to service.

**Note:** The area manager of Distribution Networks Operations (DNO) is responsible for administering Postal Vehicle Service (PVS) requirements. The DNO reviews needs, identifies and reallocates available PVS vehicles, and approves leasing in periods between national acquisitions.

221.222 **Office of Inspector General or Postal Inspection Service Vehicles**

Office of Inspector General or Postal Inspection Service (OIG/IS) surplus vehicles are vehicles that are no longer required for OIG/IS use or that are no longer suitable for law enforcement applications. When a genuine need exists, the MVM may reassign serviceable and suitable surplus OIG/IS vehicles to the non-mailhauling fleet to defer or avoid acquiring replacement vehicles.

Special agents-in-charge (SAC) should notify the OIG vehicle control officer (VCO) at Headquarters of surplus or unsuitable vehicles. Postal Service inspectors-in-charge should notify the MVM when surplus or unsuitable vehicles are available. When the OIG VCO or a Postal Service inspector-in-charge releases surplus vehicles, VMF personnel should move the surplus OIG/IS vehicles to a VMF to facilitate their processing. If surplus vehicles are not needed for reassignment locally, the MVM must first notify the area VMPA of their availability for possible transfer to other clusters. If the area VMPA determines that there is no need for the surplus vehicles, the MVM must dispose of them in accordance with chapter 7.

**Note:** The reassignment of surplus vehicles (including full-size sedans) must be cost-effective and suitable. Reassigned vehicles must reflect an appropriate professional application and image. If surplus vehicles present an image that is too "sporty" or extravagant, the MVM must dispose of such vehicles in accordance with chapter 7. Prior to vehicle redeployment or disposal, VMF personnel must ensure that all "police package" equipment (e.g., lights, sirens, and specialty radios) are removed.

**221.223 Seized Vehicles**

When the Inspection Service seizes vehicles as a result of law enforcement activity and does not redirect them for use in the Inspection Service fleet, the chief inspector or designee will notify the local MVM of seized vehicles to be released to the nearest VMF for disposal. The VMF will promptly dispose of the seized vehicles in accordance with chapter 7. With the exception of authorized Inspection Service applications, the Postal Service will not use seized vehicles in its fleet.

**221.23 New Vehicles****221.231 Purchase of Mailhauling Vehicles Restricted**

Headquarters controls the purchase of all new or replacement mailhauling vehicles for delivery and Postal Vehicle Service (PVS) applications. The Delivery and Retail group is responsible for delivery requirements, and the Network Operations group is responsible for PVS requirements. No other organization or field office may initiate a purchase of mailhauling vehicles without the specific written authorization from the senior vice president of Operations. In periods between national acquisitions, the MVM and DNO must meet local needs first by reallocating existing vehicles (see section 221.221) and then by using vehicle rental/lease (see part 221.5). Headquarters may periodically issue supplemental instructions or restrictions to the purchase, rental, or lease of mailhauling vehicles.

**221.232 Purchase of Non-Mailhauling Vehicles**

Clusters must compile and prioritize local requirements for non-mailhauling vehicles annually in accordance with field budget processes and meet those requirements through improved utilization or redeployment of existing vehicles to the maximum extent practicable. MVMs should submit residual requirements to the area VMPA, who then reviews, compiles, approves, and forwards the residual requirements to Supply Material Management (SMM) at the Philadelphia Vehicles Category Management Center (Vehicles CMC). The SMM submits the funding request to Headquarters Finance for review. Upon funding approval, each district VMF enters its approved and funded orders in accordance with the ordering instructions published on the Vehicles CMC web site at <http://blue.usps.gov/purchase/material/pmsc/philadelphia/dlphi.htm>; click on *Non-Mailhauling Vehicles*, then on *Non-Mailhauling Vehicles ordering process*, and then follow the procedures noted there.

**221.233 Restriction on Purchase of Non-Mailhauling Vehicles**

Vehicles CMC is authorized to purchase *full-size* non-mailhauling vehicles only for Postal Service vice presidents and the Postal Inspection Service. See section 221.222 for reallocation of surplus Inspection Service vehicles.

**221.234 Consideration of Alternative Fuel Vehicles Required**

The Energy Policy Act of 1992 requires that certain percentages of newly purchased or leased Postal Service vehicles be capable of using alternative fuels. (Refer to Management Instruction AS-550-1999-4, *Alternative Fuel Vehicle Program*). To the maximum extent practicable, the MVM must specify suitable alternative fuel vehicles (AFVs) when submitting requests for

light-duty vehicles — e.g., those less than 8,500 lbs. gross vehicle weight rating (GVWR) — through the area VMPA to the Vehicles CMC for acquisition (see section 221.231). Vehicles CMC may return requests for acquisition of non-AFVs to the area or cluster for additional review or information, as necessary to ensure Postal Service compliance with the Energy Policy Act.

#### 221.24 **Assignment of Older Vehicles**

The MVM will assign vehicles that are nearing replacement due to age, mileage, or high maintenance cost to locations closer to the VMF or a designated maintenance provider. When practicable, deploy them to less-demanding assignments. This will minimize overall repair cost and will avoid disruption of service at offices that may not be able to obtain prompt local maintenance service.

#### 221.3 **Vehicle Serial Numbers**

##### 221.31 **Responsibility**

The Office of Fleet Management assigns USPS numbers to all mail-hauling postal-owned vehicles except bicycles and satchel carts. All other vehicle numbers are assigned by the New York PDC Motor Vehicle Accounting Section. For AMG vehicles purchased through FY 1984, the USPS vehicle number is the last seven digits of the manufacturer's vehicle identification number (VIN). The VIN is a 17-digit alphanumeric identification prescribed by law.

##### 221.32 **Mail-Hauling Vehicle Numbers**

###### 221.321 **General**

The last digit of the fiscal year in which the vehicle was purchased is the first digit of the vehicle number. The second digit of the vehicle number designates the size or type of the vehicle; and the last five digits are sequential except for trailers and spotter tractors.

###### 221.322 **Mail-Hauling Trailers**

A second digit of "7" denotes a trailer. The third and fourth digit relate to the trailer length—22, 28, 32, 38, or 45 feet long. The fifth, sixth, and seventh digits are sequential (see Exhibit 221.322).

###### 221.323 **Spotter Tractors**

A second digit of "6" denotes a tractor, and "9" as the third digit denotes spotter service. The remaining digits are sequential.



Exhibit 221.322

**Mail-Hauling Vehicle Numbers**

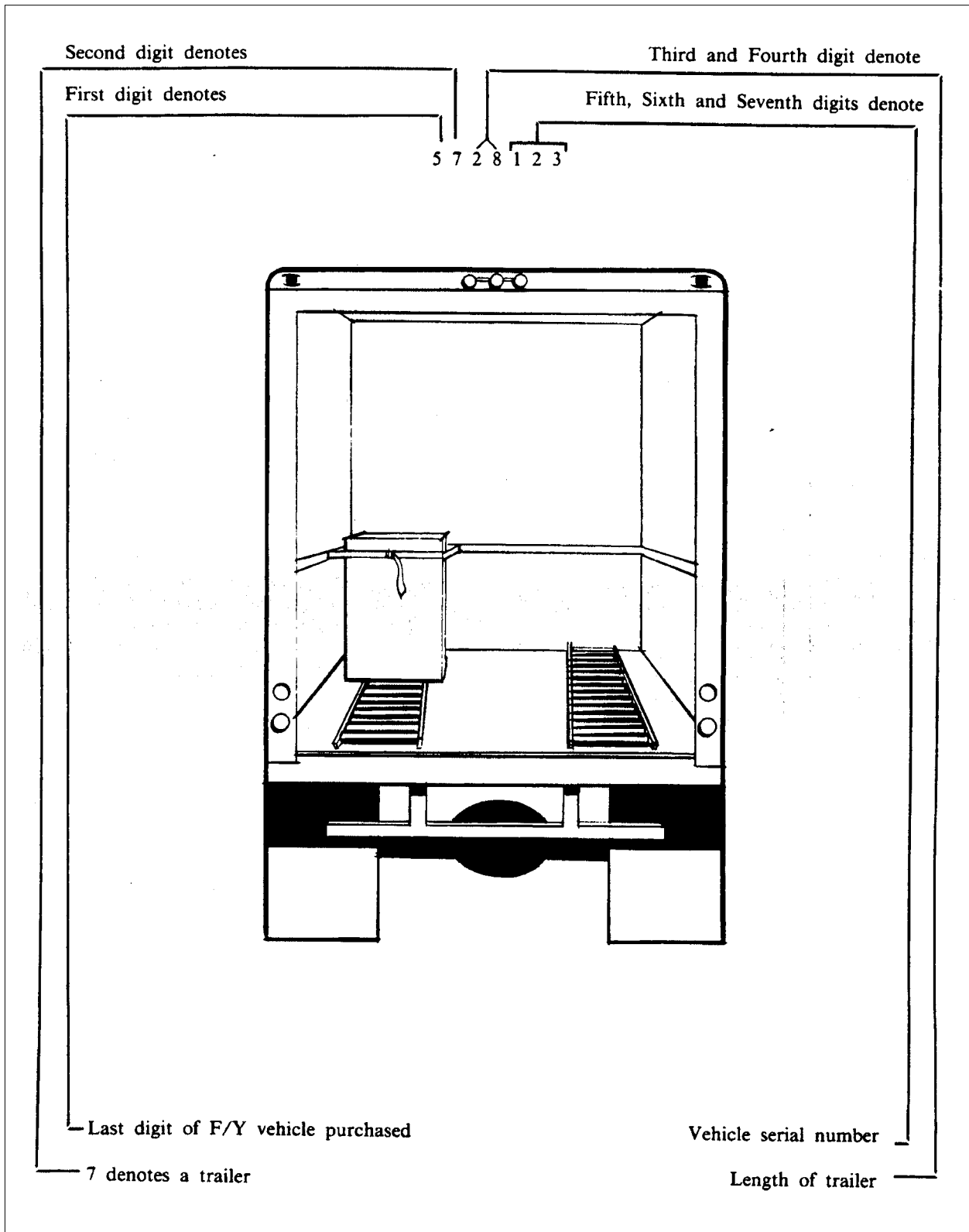

221.33 **Non-Mail-Hauling Vehicle Numbers**

The last digit of the fiscal year in which the vehicle was purchased is the first digit of the vehicle number. A second digit of "9" denotes miscellaneous service other than mail hauling. The third and fourth digits denote the type and size of vehicle (see Exhibit 221.33).

Exhibit 221.33

**Non-Mail-Hauling Vehicle Numbers**

10	- 1/4-ton
11	- Sedan
12	- Station wagon
13	- Ambulance
19	- 1/4-ton pickup
20	- 1/2-ton pickup
21	- 1-ton pickup
22	- 3/4-ton pickup
23	- 2-ton pickup
30	- 3/4-ton panel van, cargo
31	- 3/4-ton panel van, passenger
32	- 1-ton panel van, cargo
33	- 1-ton panel van
34	- 1/2-ton van, cargo
35	- 1/2-ton panel van, passenger
36	- 2-1/2 ton van, cargo
37	- 5-ton van, cargo
40	- 1-ton stake (4x2)
41	- 1-ton stake (4x4)
42	- 2-ton stake (4x4)
43	- 5-ton stake (4x2)
44	- 2-ton stake
45	- 5-ton dump
50	- 5-ton wrecker
51	- 10-ton wrecker
52	- 1-ton wrecker
53	- 6-ton wrecker
54	- 20-ton wrecker
55	- 40-ton wrecker
60	- Mobile fuel tanker
61	- Mobile self-powered P.O.
62	- Bus
63	- Tractors, non-mail hauling
64	- Auto transport, self-powered
70	- Auto transport, trailer
71	- Trailer, non-mail hauling
72	- Mobile vehicle repair shop

**221.34 P-Tags and License Plates****221.341 Installation**

P-tags or license plates are not required on postal-owned vehicles which are readily identifiable as postal-owned and conform to the registered trademark (@) postal color scheme, bear the Postal Service emblems (decals) prescribed, and have vehicle numbers displayed front and rear in at least 2-1/2 inch numbers. This provision does not apply to vehicles regularly based or housed in the District of Columbia, for which special instructions have been issued. Vehicles assigned within the District of Columbia must display license plates and original registration certificates. Original certificates will be automatically renewed. However, drivers who are ticketed for the absence of registration certificates should submit those tickets to the fleet manager. The fleet manager should, in accordance with ELM, section 667.1, submit the ticket to the regional counsel, Eastern Region, for processing. The fleet manager should request duplicate registration certificates, and a copy of that request should be placed in the vehicle pending receipt of a duplicate certificate.

**221.342 Exceptions**

Except as provided above, all other postal vehicles must be identified by P-tags. P-tags can be ordered from both Eastern and Western Area Supply Centers. DP at the division should maintain a log of P-tags issued for control purposes. MSC managers/postmasters may issue exceptions on a case-by-case basis for MSC vehicles which may require state license plates instead of P-tags. Regional Chief Inspectors may also issue exceptions on a case-by-case basis.

**221.4 Delivering Vehicles****221.41 Examination for Damage****221.411 General**

Upon receipt, check each new vehicle completely for in-transit damage. Frequent occurrences of frame and running gear damage caused by carriers warrant special attention.

**221.412 Vehicles Received Via Vehicle Drive-away**

When trucks or tractors equipped with tachographs are received via drive-away, the tachograph chart will be removed by the receiving official. Check this chart for excessive speeds by the delivering operator. Where it indicates speeding in excess of 55 miles per hour, note "speeding" prior to signing for vehicles. If the chart reveals that the vehicle has been driven in excess of 55 miles per hour, closely check the following:

- a. Check interior for damage and cleanliness.
- b. Check lift gate for damage and proper operation, if so equipped.
- c. Check odometer for high mileage.
- d. Check and note if there is any evidence of cargo usage.
- e. Check and record condition of tires. Make sure that the manufacturer's supplied tires are still on the vehicle.
- f. Check all oil and fluid levels. Look for leaks.

**221.413 Vehicle(s) Delivered F.O.B. Destination**

Vehicle(s) damaged in transit which are delivered F.O.B. destination must not be repaired by the VMF or a Postal Service contractor. Advise the contractor shipping the vehicles of damage in transit and request the contractor to provide repairs. Do not use Forms 4541 or 4543 for this action.

**221.414 Inspection of Vans**

Follow the inspection procedures below when a contractor's van is originally assigned into custody of the Postal Service:

- a. Prepare Form 5201, *Mail Van Inspection*, in triplicate, and enter on the form any defects noted during inspections.
- b. Sign Form 5201 and obtain signature of contractor's representative attesting to the condition of van as recorded on the form.
- c. Retain the original and one copy. Give a copy to contractor's representative.
- d. When the van is returned to the custody of the contractor, it is again inspected by the designated postal employee and the contractor's representative. Any new defects noted during the inspection will be annotated on both the original and the first copy of the Form 5201. Original and first copy of Form 5201 shall be signed by both, attesting to the condition of the returned van as annotated on the Form 5201.
- e. Return original to file and give first copy to contractor's representative.
- f. Enter details of the damage on Form 5201, and turn over the original to the fleet manager.

**221.42 Claims for In-Transit Damage**

When vehicle(s) are delivered to a postal installation in a damaged condition, follow this procedure:

- a. Obtain an inspection report from the delivering carrier. (Give the carrier written confirmation of all phone requests for inspections.)
- b. Note damages on a carrier delivery receipt and confirm them with an inspection report.
- c. VMF's receiving vehicle(s) with major damage (\$500 or more) will report circumstances by phone, immediately, to the DP at the Division, with written follow-up to:  
 MANAGER TRAFFIC BRANCH  
 USPS HEADQUARTERS  
 475 L'ENFANT PLAZA SW  
 WASHINGTON DC 20260-6222
- d. VMF's receiving vehicle(s) at intermediate rail off-loading points are responsible for securing an inspection report for any damages noted. Forward this report to:  
 MANAGER TRAFFIC BRANCH  
 USPS HEADQUARTERS  
 475 L'ENFANT PLAZA SW  
 WASHINGTON DC 20260-6222

- e. In the event that a VMF makes the repairs to the damaged vehicle(s) either at an intermediate off-loading point or a final destination, that VMF will be responsible for the preparation of all documentation, reports, and so forth, and their submission, including a copy of Form 4543, to:

MANAGER TRAFFIC BRANCH  
 USPS HEADQUARTERS  
 475 L'ENFANT PLAZA SW  
 WASHINGTON DC 20260-6222

- f. When repairs are made under contract, send the original invoice, prepared by the contractor, to:

MANAGER TRAFFIC BRANCH  
 USPS HEADQUARTERS  
 475 L'ENFANT PLAZA SW  
 WASHINGTON DC 20260-6222

If original invoices are not provided, fleet managers (as the receiver of the services or goods) must certify the copy with the following statement and their signature, title, and date:

“I certify that services were performed or goods received and no payment has been made.”

Signature: \_\_\_\_\_

Title: \_\_\_\_\_

Date : \_\_\_\_\_

- g. Upon receipt of the certified invoice, the Traffic Branch will approve and forward it to the PDC for payment.

**Note:** Do not use Form 4541 for contract repairs of vehicles damaged in transit.

- h. Note damages on all copies of delivering carrier’s documents and confirm by inspection report. Consignee and the delivering carrier’s representative (driver) must acknowledge the notation of damages on each document by signature.
- i. Carriers are not required to pay individual damage claims of less than \$50. However, forward all claims regardless of value to the Traffic Branch for possible batch billing of carriers, for example, three claims of \$20 against a single carrier would total \$60 and meet the billing criteria. If batch billing cannot be accomplished, the work orders or invoices will be returned to the submitting VMF for local payment under AIC 604.

221.5 **Vehicle Hire**

221.51 **Criteria**

Refer to Publication 41, *Procurement Manual*, and applicable Management Instructions. (Also refer to section 221.2.) The initial establishment of vehicle service will generally be by vehicle lease. It may not be economically feasible to assign a small number of postal-owned vehicles to a post office remote from a VMF unless high quality contract maintenance is available. Generally, vehicle lease should be used when the contract cost is lower than the prevailing rate of postal-owned vehicles of similar type, make, and model, or

when postal vehicles are not available. Make continual cost analysis of vehicle lease contracts to ascertain whether it would be more advantageous to replace the vehicles under contract with postal-owned vehicles.

221.52 **Specifications**

Specify types of vehicles by configuration category and capacity required. Do not require contractors to furnish, without additional payment, vehicles with features not specified in the approved bid solicitation. All specifications and requirements will be submitted on Form 7381, *Requisition for Supplies, Services, or Equipment*. The fleet manager and contracting officer will coordinate acceptance of vehicles.

221.53 **Rates**

221.531 **Hourly Rates**

Indicate the approximate hours and miles the vehicle is to be used each weekday and Sunday. Stipulate that payment will be made at the hourly contract rate for the actual hours of service. Vehicle lease time includes loading time and vehicle route time, even though parts of the route may be delivered on foot. However, exclude lunch periods and standing time. (Standing time is defined as the time a leased vehicle is idle at a postal facility or parking place.)

221.532 **Daily Rates**

Where beneficial, obtain daily rate contracts. Indicate the approximate number of days per year the vehicle is to be used and the approximate number of hours and miles of use per day. Stipulate that payment will be made at the daily rate for the actual days of service without regard to hours or miles used.

221.533 **Annual Rates**

Do not issue annual rate contracts.

221.534 **Alternate Rate Structures**

Vehicles may be leased on a daily, weekly, or monthly basis, as well as on a time-plus-mileage basis, to cover emergency service requirements. However, avoid this type of contract if possible.

221.535 **Hourly or Daily Rates (Gas and Oil Furnished by Postal Service)**

Only in circumstances where reasonable vehicle lease is not otherwise obtainable may vehicles be leased on an hourly or daily basis, with the Postal Service furnishing gasoline and oil. Document these circumstances in the contract, which shall remain a part of the contract file. Place the contract number on the contract vehicle instrument panel directly above the steering column. Form 4574, *Daily Record of Gasoline, Diesel Fuel, and Motor Oil Issued*, and Form 4567, *Commercial Service Station Procurement Record*, must be available so the recipient of fuel can be identified to ensure proper charges are made. Use a separate Form 4574 to record fuel issued to contract vehicles from VMF bulk storage tanks. The Form 4574 must indicate the vehicle contract number in the space provided for vehicle number, in addition to the gallons of fuel and quarts of oil. Follow VMAS instructions to enter bulk fuel issued to contract vehicles. The cost of fuel issued to contract

vehicles will be reported by the PDC as an adjustment on the Vehicle Hire Report. The separate Form 4574 will identify the fuel usage by contract number within a given office. When it is necessary to purchase fuel for contract vehicles by commercial credit card, follow the procedures outlined in VMAS instructions.

221.54 **Inspection**

221.541 **Acceptance**

Vehicles offered from commercial contractors must be inspected following award of contract. However, prior to placement into service, use Form 4577, *Leased Vehicle Condition Report*, to ensure the vehicle meets the following criteria:

- a. Vehicle must meet federal, state, and local safety standards, that is, properly functioning brakes, seat belts, and so forth.
- b. Where required, by state, an inspection sticker must be affixed.
- c. The vehicle should have an overall attractive appearance and be in suitable operating condition.

221.542 **Rejection**

Reasons for rejection must be documented on Form 4577 and submitted to the contracting officer.

221.55 **Identification**

Signs reading U.S. Mail or United States Mail are permitted on a leased vehicle only during the period the vehicle is used exclusively on Postal Service business. These signs must be applied to and removed from the vehicle by the owner and not by postal employees. Postal employees may temporarily place Notice 39, U.S. Mail, or similar signs inside the windshield. Leased vehicles designed similar to postal-owned vehicles must have the following information on each side door:

- a. Letters contrasting to the background color at least one inch high indicating: **Owned by:** \_\_\_\_\_
- b. Owner's name on trailers, two inches high on the rear and one to two feet above the bed level of the trailer.

221.56 **Maintenance and Other Contract Services**

221.561 **Maintenance**

No privately owned vehicle may be repaired or serviced under a contract for repair and service of postal-owned vehicles or by postal personnel, unless in an emergency.

221.562 **Other Contract Services**

The contractor is obligated to keep vehicles in good condition and furnish required accessories, such as tire chains, unless otherwise stated in the contract. The contractor is required to repair the vehicle and tow it in to perform the repairs, if necessary. The contractor is not required to install or remove chains, or to tow the vehicle out of mud, snow, sand, or away from an accident, unless the occurrence was due to a vehicle defect. If the contractor

performs services not required by the contract, claims for these services should be processed by the postmaster following regular procedures for paying other private parties.

**221.57 Temporary Contract Vehicle Hire**

Temporary vehicle lease contracts are not renewable. When there is a frequently recurring need for contract vehicle lease, obtain a contract to provide a standby vehicle.

**221.58 Emergency Vehicle Hire**

When an emergency occurs requiring vehicle lease for six days or less, vehicle lease may be procured locally using Form 4570, *Vehicle Time Record*, as the sole document. Identify timeclock entries on Form 4570 with each period of service. The postmaster or designee must certify on Form 8048, *Vehicle Hire*, that a vehicle was secured from the open market at the lowest possible rate under the circumstances and to the best interest of the Postal Service. Form 4570 must plainly indicate emergency service (ES) in the space provided for contract number. At the conclusion of each A/P, submit Form 4516, *Emergency Vehicle Hire Use*, to the division, with justification for each emergency in excess of six days of service within the accounting period. However, if it is anticipated that the emergency situation may exceed the limitation, obtain a temporary vehicle lease contract.

**221.6 Shipment and Transfer of Vehicles**

**221.61 National Shipments**

**221.611 Preparing Form 4503**

The post office representative at the manufacturer's plant will prepare and distribute an original and three copies of Form 4503, *Vehicle Delivery Control Sheet*, as follows:

- a. Send the original Form 4503 to the appropriate PDC, endorsed in red "Information Copy Only. This Is Not a Source Document."
- b. Send copy number 1 to DP (at region or division) of vehicle destination.
- c. Send copy number 2 to shipping destination (Postmaster, Attn: Fleet Manager).
- d. Retain copy number 3 for the file.

**221.612 Processing Form 4503**

The fleet manager at the receiving destination will:

- a. Enter the date that vehicles were received on Form 4503.
- b. Enter the office and state to which the vehicles are assigned.
- c. Enter the finance number of the final destination of the vehicles. Any changes in the original destinations for vehicles must be approved by the DP at the region.
- d. The fleet manager at the appropriate destination will forward the receipted copy of Form 4503 to the New York PDC within three working days of receipt of vehicles.



**221.613 Designated Personnel at the PDC**

Designated personnel at the PDC will:

- a. Upon receipt of the destination copy of Form 4503, verify the accuracy of information.
- b. Input required data into the Vehicle Asset System.

**221.62 Regional/Local Procurements****221.621 Requiring Installation**

- a. Complete a separate Form 4503 for each finance number to which vehicles are assigned.
- b. Complete all sections of Form 4503.
- c. Obtain all non-mail-hauling vehicle numbers that are assigned by the New York PDC Motor Vehicle Accounting Section.

**221.622 Designated Personnel at the PDC**

- a. Verify accuracy of receipted Form 4503.
- b. Input required data into the Vehicle Asset System.

**221.63 Informal Transfer Procedures**

Intraoffice transfers may be made at the discretion of the fleet manager without formal transfer procedures, except transfers involving a change in make/model (M/M). All other transfers between VMF offices, divisions, and regions may be authorized on Form 7340-A, *Shipping Instructions for Excess Property-Vehicle*, by the DP at the region. This form is available through normal supply channels.

**221.64 Types of Transfers****221.641 Operations Assignments Transfers**

The transfer of vehicles for operating assignments is an operating cost. Charge required driving time to the motor vehicle operators account. If there are no motor vehicle operators assigned, record time used by postal employees in the transfer of vehicles as outlined in Handbook F-21, *Time and Attendance*. Normally, supervisors should not be used to transfer vehicles in accordance with Section 6, Article 1, National Agreement. Assign vehicle maintenance employees to make operating transfers when:

- a. The mechanical condition or the mileage involved warrant the assignment of a vehicle maintenance employee to ensure completion of the transfer.
- b. Repairs or inspections on other vehicles may be made en route.
- c. New vehicles are assigned to a vehicle post office for the first time and an audit is necessary to instruct personnel at that office in the proper maintenance operation of the vehicles.

**221.642 Maintenance Assignments Transfers**

The shuttle or transfer of vehicles for maintenance purposes is properly a vehicle maintenance cost. Charge the required driving time to the applicable VMF account. Where carriers or motor vehicle operators perform shuttle or

transfer of vehicles for maintenance purposes, identify travel time and ensure proper allocation of work hours, as outlined in Handbook F-21.

## 222 Vehicle Scheduling

### 222.1 Responsibility

#### 222.11 Mail Processing

Mail Processing should provide the fleet manager with a list of required receipts and dispatch times.

#### 222.12 Customer Services

Customer Services should furnish a list for all delivery and firm requirements.

#### 222.13 Fleet Manager

The fleet manager is responsible for ensuring the reasonableness of the required service and for preparing:

- a. MVS schedules using Form 4533, *MVS Schedule*.
- b. Clear and concise routes of travel.
- c. MVS Master Vehicle Schedule Summary, prepared by using local formats (see Exhibit 222.13c).
- d. A separate summary of service for each service point, using Form 1542, *Service Point Delivery Requirements*.

Exhibit 222.13c

### U.S. Postal Service MVS Master Vehicle Schedule Summary

Schedule Number	First Service Point Contact	Segment Number	Size Vehicle By Segment	Start Time	End Time	Swing Time	Paid Time	Available Time		
								From	To	Duration
201	Sta 19	1	38' Trailer	0600	1445	0045	0800	1015	1115	0100
		2	5-Ton					1350	1405	0015
		3	5-Ton							
204	Sta 24	1	38' Trailer	0610	1453	0035	0800	None		
		2	5-Ton							
		3	5-Ton							
216	Strong's	1	5-Ton	1110	1940	0030	0800	1412	1448	0036
		2	5-Ton							
		3	5-Ton							
		4	5-Ton							

**222.2 Developing Schedules****222.21 Delivery Services Schedules**

The format and construction of delivery services schedules are the responsibility of delivery services supervisors.

**222.22 Intracity and/or Intercity Schedules**

Prepare MVS schedules on Form 4533, *MVS Schedule*, which are available in the supply centers in three types: individual preprinted sheets, die-impressed stencils, and die-impressed duplicates. Use white paper for daily schedules, blue paper for Saturday schedules, and pink paper for Sunday and holiday schedules. The form is designed to coincide with Form 4572, *Tractor Log*, and Form 4575, *MVS Vehicle Survey*. Instructions for completion of Form 4533 are printed on the reverse side of the form. (See Exhibit 222.22.)

**222.23 Service Point Summary**

The fleet manager will prepare a service point summary using the format in Exhibit 222.23 for each service point. Fleet operations shall provide service point managers with their respective copies of the summary. The summary of firms shall be provided to customer services managers.

**222.24 Filing Vehicle Schedules**

Maintain, in the Vehicle Dispatch Office, an adequate supply of all route or run schedules so that all drivers may be properly informed of the schedule to be followed and the route to be used. Drivers should also be alerted to any deviations.

**222.25 Unscheduled Service**

In major cities with large terminal or sectional center operations, service may be improved and savings made by unscheduled service. Operators working regular tours of duty are dispatched from point to point, moment by moment. This requires that dispatchers be alert and responsive to the needs of the service within the postal area covered. Waiting time and deadhead travel can be greatly reduced by the judicious use of this regular but unscheduled service. Limit the number of runs in this category to the number required for full manpower utilization on the lighter days of the week.

**222.26 Relay Service**

Motor vehicle service runs at the outward end of a trip may perform relay and collection service (a function provided for in the position description of motor vehicle operator), and should be included on Form 4533, *MVS Schedule*, if applicable.

Exhibit 222.22 (p. 1)  
**Form 4533, MVS Schedule**

U.S. Postal Service <b>MVS SCHEDULE</b>			Post Office and ZIP + 4 Anytown, USA 22222-2222			
Effective Date 12/1/76	Supersedes 10/1/75	Frequency K67	Schedule Miles 33.7		Schedule No. 216	
Range From 1110 To 1940		Swing(s) 1510-1540	Paid Time 8:00	Vehicle Cap. Req. 5T	Regular Truck No. 6800483	

Service Point		Arrive	Leave	Operating Instructions
Number	Name			
	Annex	1110	1125	Not. 76 Veh. Inspection - Load Strong News
	Strongs	1135	1155	Pick Up Empty Equipment
	Main Office	1203	1221	Load all mail for SS Annex, Sunnyslope, Sta. 19, 18, 24, 12
	SS Annex	1239	1246	Load All Mail
	Sunnyslope Sta. Sta. 24	1300	1312	Load All Mail & Box Mail for Sta. 24
	Sta. 19	1324	1330	Load All Mail & Collect Front Box
	Main Office	1347	1350	Load All Mail
		1404	1412	Initial Sign-In Sheet
	Available	1412	1448	Report to Dispatcher
	Main Office	1448	1500	Load Annex Mail
	Annex	1505	1510	Unload Truck
	Lunch	1510	1540	
	Annex Plaza	1540	1545	Take 1 Empty APMC for Glendale
		1556	1601	All Mail
	Glendale	1623	1639	All Mail for Luke Field, Sun City, El Mipage, Peoria, and Youngstown
	Luke Field	1700	1710	Load All Mail
	El Mipage	1721	1726	Load All Mail
	Youngstown	1733	1740	Load All Mail
	Sun City	1750	1800	Load All Mail & Pick Up Box Mail in Sun City Shopping Center
	Peoria	1805	1810	Load All Mail
	Glendale	1820	1835	Unload Sectional Center Mail Only. Pick up All First-Class and Parcel Post
	Main Office	1850	1905	Unload First-Class Only - Load Parcel Post for Annex
	Annex	1913	1921	Unload Truck
	Available	1921	1930	
	Annex	1930	1940	Gas & Notice 76 Inspection
IN EVENT OF:				
BREAKDOWN: Call Garage Area Code (21X) 171-1468				
ACCIDENTS: Call Control Unit Area Code (21X) 171-1925				

Annual Totals (Exclude swing hours)						
Miles	Hours	Night diff. Hrs	Week Day Hours	Saturday Hours	Sunday Hours	Holiday Hours
8503.1	2,019	421	2019			

PS Form 4533, Mar. 1987

Exhibit 222.22 (p. 2)

**Form 4533, MVS Schedule**

<b>Instructions</b>	
<p>The form is designed to coincide with entries on Form 4575, Vehicle Load Check.</p> <p>The headings should be completed in full. The body of the form will list each stop of the schedule or run beginning at the garage or parking point.</p> <p>In the column, "Operating Instructions," class of mail handled shall be indicated along with special instructions, such as "Unlock station, place mails inside, hold 15 minutes, etc."</p> <p>Swing period should be indicated in the headings showing the</p>	<p>span and in the body of the schedule at the appropriate place.</p> <p>Use the 24-hour clock in minutes throughout so that there will be no mistaking A.M. or P.M. hours.</p> <p>Under the column "Service Point," enter each scheduled stop line by line.</p> <p>Additional instructions such as route of travel, need for arms, for special keys, etc., should be entered at the bottom of the form or below.</p>
<b>Additional Instructions</b>	
<p>PS Form 4533, Mar. 1987 (Reverse) <span style="float: right;">*U.S.GPO:1987-0-181-700/02852</span></p>	

Exhibit 222.23

**MVS Service Point Summary**

City		State		ZIP + 4		Service Point Name			Date		
Schedule Number	Segment Number	Vehicle Type	Depart		Previous Contact Point	Station Time			Next Contact Point	Arrive	
			Depot	Time		Arrive	Leave	Duration		Depot	Time

## 223 **Vehicle Dispatching**

### 223.1 **Dispatch Point Operations**

Maintain completed Form 4569, *Vehicle Use Plan*, at each dispatch point, indicating the planned use of every vehicle based at the dispatch point. Keep the form accurate and current at all times. List all postal-owned vehicles and group them according to capacity in consecutive numerical order, beginning with the lightest capacity. List regularly used leased vehicles following postal-owned vehicles.

### 223.2 **Citywide Operations**

Maintain a current Form 4569 in the office of the fleet manager to display the scheduled service for the entire fleet. Form 4569 should indicate the planned use of every assigned vehicle. Keep the form accurate and current at all times. First, list all postal-owned vehicles in the fleet, according to basing points and then according to capacity in consecutive ascending numerical order, beginning with the smallest tonnage. Indicate trucks not regularly scheduled with the word "reserve." List regularly used leased vehicles after postal-owned vehicles at each basing point. For fast identification, prepare visual control panels as a wall display, providing information on Form 4569. (See Exhibit 223.2) To obtain maximum usage with a minimum number of vehicles, schedule trucks for two or more tours wherever possible. Make every effort to assign dual services to smaller capacity vehicles assigned primarily to motorized routes. Whenever possible, schedule vehicles for assignment to the same driver(s) daily. Do not, however, hold vehicles for a particular driver if it has an adverse impact on vehicle use or will result in the delay of any drivers in beginning their assignments.

### 223.3 **Time-Oriented Movement Control Systems (Optional)**

#### 223.31 **Pegboard System**

More complex operations with tractor-trailer service and extensive truck shuttle may require time-oriented movement control systems depicting major stop points and transit and loading times. For these operations, pegboard systems offer the greatest versatility. Horizontal lines represent the stop or dispatch points. Vertical rows indicate elements of time, generally five minutes. In this manner, a pegboard five feet wide provides a control span of four consecutive hours, leaving room for lettering locations at the side. As the trucks move from point to point, the identifying peg is moved from left to right anticipating the arrival at the next stop. As each one-hour time segment of the board is cleared of vehicles, or as the actual time of day demands, the time headers are advanced four hours. Thus, the board becomes a perpetual time indicator. (See Exhibit 223.31.)

Exhibit 223.2  
Sample Visual Control Panel

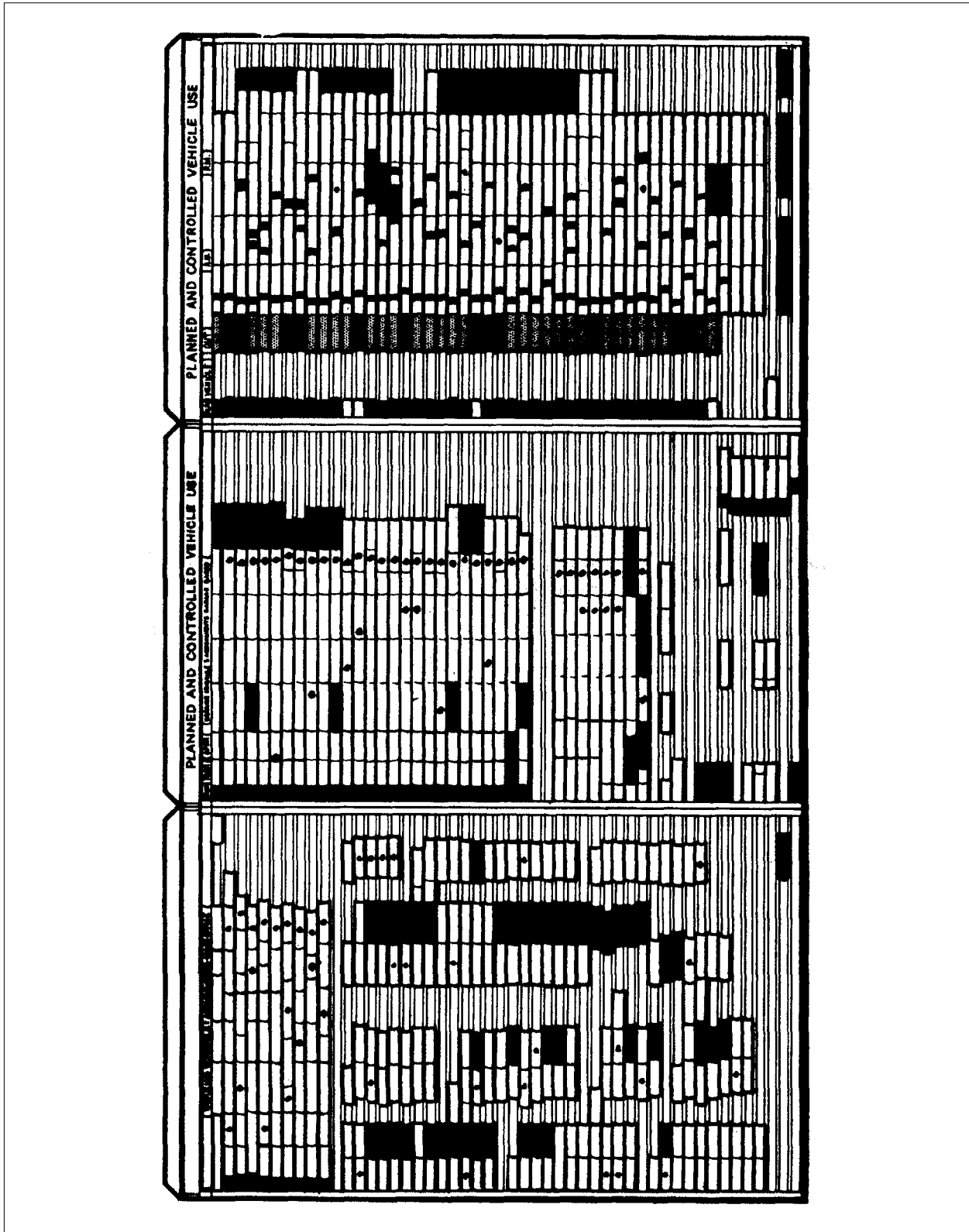



Exhibit 223.31  
**Optional Control Boards**

# Time Segmented Control

<b>ASSIGNMENTS</b>
<b>RUNS</b>
o o

<b>ACTION CONTROL - MVS</b>				
Location	1	2	3	4
U. 6	.....	••		
D. 1, 2		••	•	
LAS-6		•		
B & O		•	•	
M.O.		•	•	
T.T.			•	

<b>SHOP</b>
••••
o
<b>PARKING</b>
•••••

# Perpetual Time Control

<b>HOURS</b>				
Location	1	2	3	4
U. 6		•		
D. 1, 2		•		
LAS-6		••		
B & O		•		
M.O.		•		
T.T.		•	•	

Location	5	6	3	4
U. 6			•	
D. 1, 2			•	•
LAS-6			•	•
B & O			•	•
M.O.			•	
T.T.				

**223.32 Magnetic Boards**

Procure adequate magnetic vehicle control boards locally through the PSO to obtain better pricing. Each office must tailor its control board to meet the specific demands of the office. For ease of operation, locate stops or dispatch points receiving the major portion of vehicle activity within easiest reach of the board operator.

**223.4 Terminal Operations Control Boards (Mandatory)**

Some of the larger post offices are responsible for trailer spotting activities and movement control at major truck terminals. Under these circumstances, a control board must be developed depicting each bay and parking location of the terminal. By using rectangular tags to indicate vehicles, an accurate control of vehicle movements, loading, and dispatch is achieved. Number vehicle tags on both sides; a red stripe on one side denotes a loaded vehicle. Where vehicles used change frequently, use high-gloss plastic tags, entering the vehicle number with a grease pencil when the truck or trailer enters the terminal area, and erasing the number when the vehicle leaves the area. Where postal vehicle service is used, a smaller round tag will indicate the postal vehicle service run number; thus, a combination of the three tags will indicate route, trip, leaving time, vehicle, and run numbers. The tags are placed in the appropriate places on the board to indicate loading, holding for unload, parking, empty, or trips on the road. (See Exhibit 223.4.)

**223.5 Railroad Van Control****223.51 Visual Control**

Movement control of flexi-vans and other railroad van equipment is becoming increasingly complex. Visual control of the unit is necessary from a service and cost standpoint. Effective control prevents demurrage charges. Since the equipment numbers will vary from day to day, a plastic tag similar to the trip tag illustrated in Exhibit 223.4 can be adopted for use on the control board. The equipment identification number can be printed on the tag with a grease pencil and can be erased for re-use when the vehicle is cleared from the area. (See Exhibit 223.51.)

**223.52 Form 4539, Railroad Van Movement Log**

Form 4539, *Railroad Van Movement Log*, is a detailed form used to properly document street movements within a postal district, eliminating unnecessary demurrage charges. Use this form in conjunction with rail van movement.

Exhibit 223.4  
**Mandatory Control Boards**

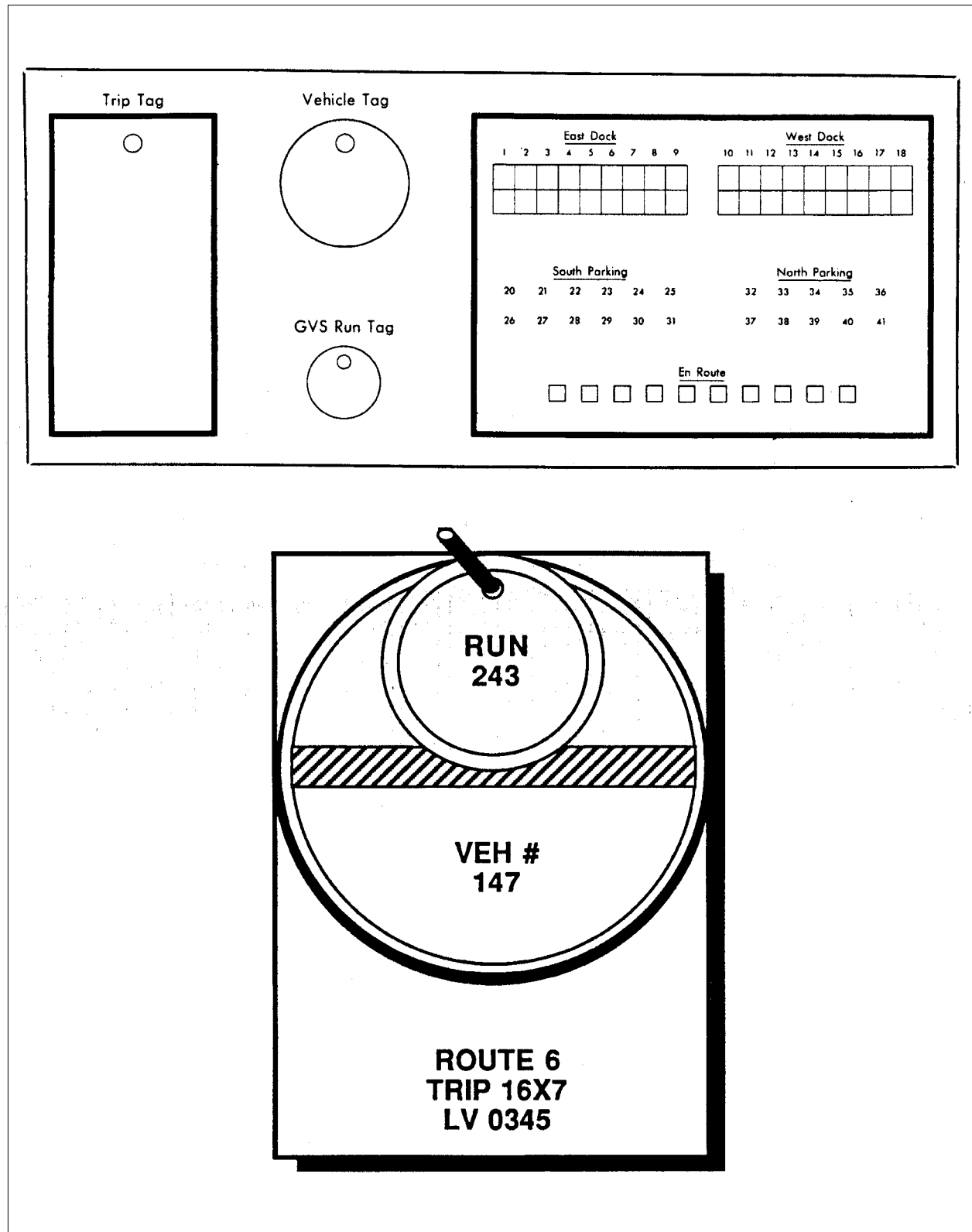
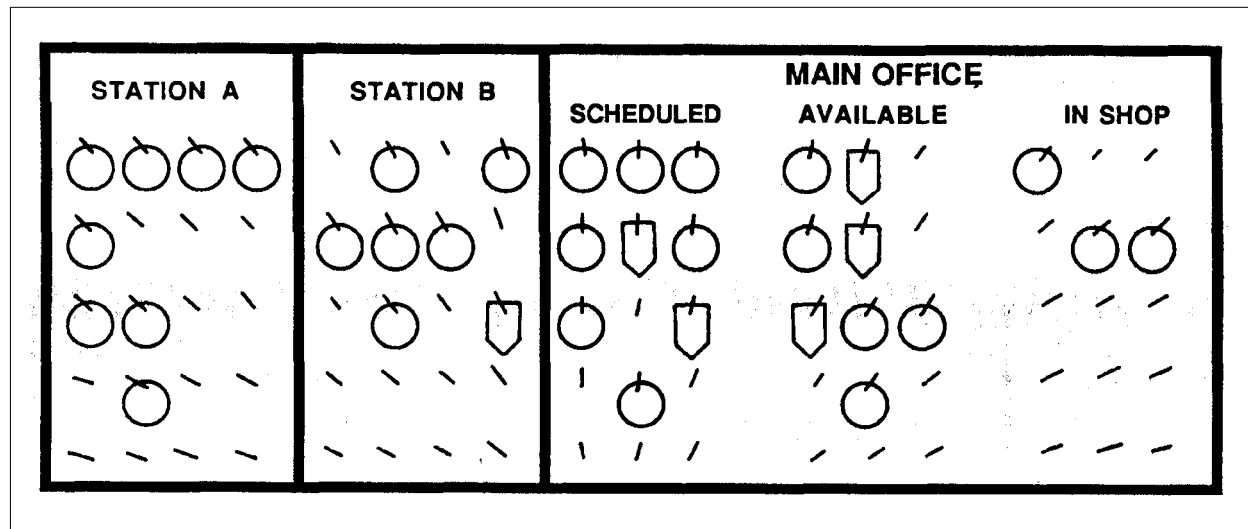

Exhibit 223.51

**Tagboard-Assignment Schedule**



**223.6 Two-Way Radio Control**

Two-way radio control for vehicle movement has proven effective in terms of improved productivity in a wide range of offices. Maximum beneficial usage of the two-way radio system is realized through tractor-trailer operation and nonscheduled service. Mobile radio units in maintenance and analyst vehicles expedite communication in terms of identifying location and anticipated time of arrival at the base facility. Two-way installation may be recommended by a post office with a vehicle operations unit. Submit full justification through channels to the division or region for review and final disposition.

**223.7 Form 4572, Tractor Log**

In very large offices with extensive unscheduled tractor-trailer movements, each operator must maintain a Form 4572, *Tractor Log*, on a daily basis. During vehicle utilization surveys, use Form 4575, *MVS Vehicle Survey*. Dispatchers will provide tractor logs to operators at the beginning of each run. Drivers must complete the log, indicating each move made throughout the run. Dispatchers will advise operators on the proper completion of the log to ensure accuracy (see Exhibit 223.7). Designated personnel at the division will determine the post offices required to complete a daily Form 4572.

Exhibit 223.7 (p. 1)  
Form 4572, Tractor Log

U. S. Postal Service TRACTOR LOG													
Tour of Duty <input type="checkbox"/> 1 <input type="checkbox"/> 2 <input type="checkbox"/> 3			Tractor No.			Date			Assignment				
Dispatch Point			Operator's Name			Run No.			<input type="checkbox"/> Scheduled <input type="checkbox"/> Unscheduled				
						Run Begins <i>(Scheduled Veh. Time)</i>			Run Ends <i>(Scheduled Veh. Time)</i>				
Time Begins				Time Ends				Speedometer Readings					
								Ending Mileage		Beginning Mileage		Miles Traveled	
**Arrival Time	Check Point	Trailer		*Load Factor Off	Trailer		*Load Factor Off	Service Code	Verified By	**Departure Time			
		No.	Length		No.	Length							
*Where possible, load factor will be indicated in pieces; otherwise percentage of load. **Make pencil entries unless your superior directs you to use time clock.							Service Code D-Depot      L>Loading      IR-Interstation L>Loading      AM-Airmail      M-Miscellaneous						

PS Form 4572, May 1987 (Complete CHECKLIST on reverse)

Exhibit 223.7 (p. 2)  
**Form 4572, Tractor Log**

**VEHICLE OPERATOR'S PRE-TRIP CHECKLIST**

INSIDE

- Parking Brake (*Apply*)

START ENGINE

- Oil Pressure
- Air Pressure or Vacuum
- Instrument Panel
- Horn
- Windshield Wiper & Washer
- Heater - Defroster
- Mirrors
- Steering Wheel (*Excess Play*)
- Apply Trailer Brake
- Turn On All Lights / Flashers
- Fire Extinguisher / Warning Devices
- Seat Belt

OUTSIDE - FRONT

- Headlights
- Clearance Lights
- Identification Lights
- Turn Signals / Flashers
- Tires & Wheels (*Lugs*)

Remarks

REAR

- Tail & Stop Lights
- Turn Signals / Flashers
- Clearance Lights
- Identification Lights
- Reflectors
- Tires & Wheels (*Lugs*)
- Rear End Protection (*Bumper*)

RIGHT SIDE

- Fuel Tank & Cap
- Sidemarker Lights
- Reflectors
- Tires & Wheels (*Lugs*)

INSIDE

- Stop Engine
- Release Emergency Brake
- Apply Service Brakes
- Air Loss Should Not Exceed:
  - 3 PSI On Single Vehicles
  - 4 PSI On Combinations

LEFT SIDE

- Fuel Tank & Cap
- Sidemarker Lights
- Reflectors
- Tires & Wheels (*Lugs*)

\_\_\_\_\_  
*(Driver's Signature and Date)*

\_\_\_\_\_  
*(Supervisor's Signature and Date)*

## 23 Vehicle Utilization Surveys

---

### 231 Purpose and Scope

Vehicle utilization surveys are the tools for indepth analysis of the operation and management of all vehicle service. Vehicle utilization surveys are divided into two categories: delivery service operations and motor vehicle service operations. The purpose of vehicle utilization surveys is to determine whether:

- a. Full service requirement is met with the minimum number of postal-owned and leased vehicles or other contractual services.
- b. Required service is provided with the smallest possible number of vehicle hours used and miles operated.
- c. All vehicle usage is integrated to the maximum extent, thus ensuring optimization and avoiding duplication and overlapping of service.
- d. Requested service is justified by volume and need.

### 232 Basic Surveys (Delivery Service Operations)

#### 232.1 Definition

Basic surveys are for post offices where vehicle operations are confined primarily to delivery services. The manager, Vehicle Programs, will coordinate with delivery services a basic survey to be performed at least once each year to determine proper vehicle utilization. Form 1542, *Service Point Delivery Requirements*, and Form 4569, *Vehicle Use Plan*, must be completed and maintained for all delivery units.

#### 232.2 Procedures

Where all driving assignments are performed by carriers or special delivery messengers, make a one-day basic vehicle utilization survey. Required source data to complete Form 4569, *Vehicle Use Plan*, will be taken from Form 1597, *Work Assignment and Mail Count (Messenger Operations)*; Form 1838-A, *Carrier's Count of Mail—Parcel Post and Combination Services Worksheet/Management Summary*, 1838-B, *Parcel Post Firm Delivery Worksheet*, and 1838-C *Carriers' Count of Mail—Letter Carrier Routes Worksheet*; Form 3999, *Inspection of Letter Carrier Route*; and Form 4570, *Vehicle Time Record*. Delivery service forms provide useful information concerning vehicle utilization, volume, and so forth. Review these forms and the postal data center printouts periodically.

#### 232.3 Analysis

##### 232.31 General

Analysis of vehicle use in delivery service functions may require study of Form 1542, *Service Point Delivery Requirements*; Form 4569, *Vehicle Use Plan*, Form 4575, *MVS Vehicle Survey*, and delivery forms, such as

Form 1597, *Work Assignment and Mail Count (Messenger Operations)*, Form 1838-C, *Carriers Count of Mail—Letter Carrier Routes Worksheet*, Form 3999, *Inspection of Letter Carrier Route*, Form 3999-A, *Deliveries/Inspection Record Worksheet*, and Form 3999-B, *Inspection of Collection Route*.

## 232.32 **Specific Areas of Analysis**

### 232.321 **Motorized Routes**

Check leaving time on Form 4569, *Vehicle Use Plan*. Compare to station opening time (as shown on Form 1542, *Service Point Delivery Requirements*), carrier-route time, and receipt of interstation mail. Determine the availability of the vehicle for other use during office time periods, the capability of motorized routes to handle some relay for foot routes along the motorized route line of travel, possible use of vehicle for area collections after regular route time, surplus vehicles assigned to stations (Form 4569) and possible use of unused time to deliver parcel post.

### 232.322 **Parcel Post**

Using Form 1838-A, determine travel time from VMF to mailing unit (if applicable) and waiting time at dock during carrier's office time. (Could this vehicle time be used more productively?) Check deadhead travel time to first stop and return deadhead travel from last stop. Where excessive, determine possibility of station basing to reduce deadhead travel time. Using Form 4569, determine whether vehicle can be used for additional service or whether route can be carried by another vehicle presently assigned to other services. Where more precise vehicle use data is required, use Form 4575, *MVS Vehicle Survey*.

### 232.323 **Collection Service**

Determine deadhead travel time, waiting time at docks, and the potential of area collections to meet scheduled shuttle trips. Review thoroughly to ascertain whether arterial collections can be carried by existing MVS, thereby releasing carrier and vehicle for more productive work.

### 232.324 **Relay Service**

Determine deadhead travel time to collect relays, lost time at stations waiting for relays, and elapsed relay delivery time. Review alternate methods of handling relays, such as motorized routes, use of station-based vehicles prior to their primary use, or existing MVS runs.

### 232.325 **Carrier-Operated Interstation Service**

Where service is extensive, involving several full-time routes dedicated solely to interstation dispatch, determine cost of service and consider the following alternatives:

- a. Convert to MVS operation.
- b. Convert to contract service.
- c. Consolidate segments of several full-time routes for better use of employees and vehicles.



**232.326 Special Delivery Service (See Form 1597)**

Review deadhead travel times. Determine time lost at docks. Develop delivery rate. Determine potential for station basing. Consolidate vehicle usage to assign trucks to two consecutive tours wherever possible.

**233 Secondary Surveys (Motor Vehicle Service Operations)****233.1 Definition**

Secondary surveys are for post offices having motor vehicle service units or intracity and/or intercity services by postal employees to and from four or more points. Secondary surveys are mandatory and must be completed at least once every year, or more frequently as required by the installation head or higher level of management.

**233.2 Procedures**

Where intercity, intracity, depot, shuttle, and airmail services are performed, the following instructions apply:

- a. Make a survey of MVS activities for one or more days, up to one week.
- b. Complete Form 4575, *MVS Vehicle Survey*, for all motor vehicle service runs, including Saturday and Sunday, if required.

**233.3 Preparing Survey Forms****233.31 Form 4575, MVS Vehicle Survey**

Initiate Forms 4575 for all MVS vehicles, including postal-owned and contract (see Exhibit 233.31). If the vehicle is not used on the day of the survey, Form 4575 must be appropriately endorsed. Determine the following: load factor on each segment, trip, and run; method used to handle mail sacks, pouches, and containers; the relationship of vehicle capacity to load carried (too large? too small?); excessive platform or office time in relation to mail carried; the running time between service points; deadhead travel time to and from route; and review schedules for unused segments where little or no work is performed. Mark these for further analysis on Form 4575. Note obvious extensions to make eight-hour runs and verify by comparing Forms 4575-A. On relay runs, determine time lost waiting for relays, elapsed time for relay deposit, and number of pieces handled. Also determine excessive use of drivers, especially tractor-trailer operators, to load and unload, and the total route miles.

Exhibit 233.31

**Form 4575, MVS Vehicle Survey**

U.S. POSTAL SERVICE																	
MVS VEHICLE SURVEY																	
DISPATCH POINT			DATE		VEHICLE NO.			CAPACITY			OPERATOR'S NAME						
SPEEDOMETER READINGS (Estimate if odometer inoperable)				SCHEDULE OR ASSIGNMENT				REVIEWED BY (Supervisor)									
MILEAGE				MILES TRAVELED				ROUTE NO. <input type="checkbox"/> REG. <input type="checkbox"/> SCHED.				<input type="checkbox"/> AUX. <input type="checkbox"/> NON-SCHED.					
ENDING		BEGINNING		SCHEDULED VEHICLE TIME				DATE OF REVIEW									
				BEGINS				ENDS									
<p><b>INSTRUCTIONS FOR LOAD COUNT:</b> Columns 4, 5, 6, may be identified by rubber stamp for local needs. NOTE: Load On will normally equal Load Off on each trip.</p> <p><b>SERVICE CODE:</b> AM – Airmail IS – Inter-Station IC – Inter-City PL – Park &amp; Loop PP – Parcel Post                      M – Miscellaneous SD – Special Delivery C – Collection R – Relay MR – Motorized</p> <p><b>NOTE:</b> See sample on reverse.</p>																	
ARRIVE TIME (24 HOUR CLOCK IN MINUTES)		CHECK POINT	LOAD OFF						LOAD ON						SERVICE CODE	DEPART TIME (24 HOUR CLOCK IN MINUTES)	
HR.	MIN.		BMC CONTAINER	LARGE HAMPER	GENERAL PURPOSE CONTAINER	(4)	(5)	(6)	BMC CONTAINER	LARGE HAMPER	GENERAL PURPOSE CONTAINER	(4)	(5)	(6)		HR.	MIN.

PS Form 4575  
Nov. 1979

**233.32 Form 4575-A, Five Day Summary—MVS Vehicle Utilization**

This form offers comparison of each run, segment by segment. (See Exhibit 233.32.) Irregularities or inconsistencies reported at the same points each day indicate need for correction or elimination. In particular, review the following:

- a. Comparison of actual versus scheduled operation.
  - (1) Actual running time less than scheduled.
  - (2) Consistent failure to maintain schedule.
  - (3) Location and cause of delay.
- b. Segments of service showing little or no volume each day.
  - (1) Make-work assignments in the middle of a run.
  - (2) Unproductive work at the end of a run to fill out a tour.
- c. Consistent deadhead travel at the same points each day.
- d. Improper vehicle type for work requirements.
- e. Possibility of container movements.
- f. Correlation with other runs covering similar time periods.
  - (1) Note inconsistencies or problem areas developed (as indicated in 233.31) on each Form 4575-A and identify nonproductive segments for possible elimination from the schedules.
  - (2) Compare all Forms 4575-A covering similar time ranges and eliminate duplication and nonproductive trips by consolidating runs, changing vehicle type, revising leaving time, and so forth.
  - (3) Ensure dispatches to stations are productively geared to carrier leaving times. Compare to Form 1542. Consider opening stations by motor vehicle operator where service may be improved at less cost.
  - (4) Explore possibility of containerizing mail where heavy sack volume requires lengthy loading time.

**233.33 Form 4572, Tractor Log**

Refer to 223.7, Form 4572, *Tractor Log*.

**233.34 Form 4569, Vehicle Use Plan**

See Exhibit 233.34. Study Form 4569 to develop potential consolidation of services to free vehicles. Assign vehicles to two full tours where possible. Prepare a new schedule summary of proposed service on Form 4569.

Exhibit 233.32 (p. 1)  
Form 4575-A Five Day Summary—MVS Vehicle Utilization

U.S. Postal Service  
**FIVE DAY SUMMARY - MOTOR VEHICLE SERVICE  
VEHICLE UTILIZATION**

Post Office City, State, and ZIP Code

From: \_\_\_\_\_ To: \_\_\_\_\_  
Prepared by: (Name and Title)

Run No. Start End Swamp	MONDAY		TUESDAY		WEDNESDAY		THURSDAY		FRIDAY		ASSIGNED VEHICLE											
	OFF	ON	OFF	ON	OFF	ON	OFF	ON	OFF	ON	Number	Cube										
ARR LV	1	2	3	4	5	6	7	8	9	10	1	2	3	4	5	6	7	8	9	10		
ARR LV																						
ARR LV																						
ARR LV																						
ARR LV																						
ARR LV																						
ARR LV																						
ARR LV																						
ARR LV																						
ARR LV																						
ARR LV																						

DISPATCH POINTS

PS Form 4575-A, Dec 1987

(See Instructions on Reverse)

Exhibit 233.32 (p. 2)  
Form 4575-A Five Day Summary—MVS Vehicle Utilization

**SATURDAY-SUNDAY ANALYSIS - MOTOR VEHICLE SERVICE**

INSTRUCTIONS	SATURDAY		SUNDAY		REMARKS AND ANALYSIS	
	SCHEDULE		SCHEDULE			
	Run No. Start End Swing	On Off	Run No. Start End Swing	On Off		
<p><b>INSTRUCTIONS</b></p> <p>Form 4575-A is designed for comparative analysis of Forms 4575 for all MVS service. It may also be used for secondary analysis of other services in the course of special surveys.</p> <p><b>FIVE-DAY SUMMARY - (FACE OF FORM)</b></p> <p>For intrastate and shuttle schedules Monday through Friday, complete Form 4575-A as follows:</p> <ol style="list-style-type: none"> <li>In the left column under RUN NO. enter starting, ending and swing time as indicated, using the 24-hour clock.</li> <li>From the schedule of run being analyzed, enter each dispatch point line-by-line, showing scheduled arrival and departure time.</li> <li>From the appropriate Form 4575, enter volume counts in appropriate OFF and ON columns and show arrival and departure time vertically in the column provided.</li> <li>For clarity, show loads OFF in red, loads ON in blue.</li> </ol> <p><b>SATURDAY-SUNDAY - (REVERSE OF FORM)</b></p> <ol style="list-style-type: none"> <li>Where the identical schedule operates Monday through Saturday, ignore Saturday schedule column. Where the schedule differs, enter the Saturday schedule in SCHEDULE column. Enter Saturday's Form 4575 entries in the ACTUAL column.</li> <li>Where Saturday and Sunday schedules have individual run numbers, indicate the run number and enter the schedule in the appropriate column. Complete Saturday and/or Sunday analysis as above.</li> </ol> <p><b>ANALYSIS:</b></p> <ol style="list-style-type: none"> <li>Determine validity of service to each dispatch point by analyzing volume counts through the week.</li> <li>Compare the arrival and departure time at each dispatch point to determine whether schedules are maintained and whether loading time is adequate, inadequate, or excessive.</li> <li>Compare the departure time at one dispatch point against arrival time at the next point to determine whether travel time between stops is realistic.</li> <li>Enter comments concerning irregularities in loading time, volume or travel time in the REMARKS column, indicating unjustified service by a red "X".</li> <li>Compare completed Forms 4575-A for runs covering the same or overlapping time spans to consolidate runs and facilitate speedy development of more efficient schedules.</li> </ol> <p><b>INSTRUCTIONS FOR LOAD COUNT:</b></p> <p>Column 1 = BMC Container.            Column 2 = Larger Hopper.            Column 3 = General Purpose Container.            Column 4, 5, 6 = May be identified as local needs dictate.</p>	Run No. Start End Swing	On Off	Run No. Start End Swing	On Off		
	ARR LV			ARR LV		
	ARR LV			ARR LV		
	ARR LV			ARR LV		
	ARR LV			ARR LV		
	ARR LV			ARR LV		
	ARR LV			ARR LV		
	ARR LV			ARR LV		
	ARR LV			ARR LV		
	ARR LV			ARR LV		

U.S. GPO: 1985-365-116/1000

Exhibit 233.34 (p. 1)  
Form 4569, Vehicle Use Plan

U.S. Postal Service VEHICLE USE PLAN (For Postal-Owned and Affiliated Vehicles)		U.S. Postal Service Branch/Station	U.S. Postal Service Survey Dates	U.S. Postal Service Proposed Schedules	U.S. Postal Service Unassigned Office	U.S. Postal Service Survey Dates	U.S. Postal Service Reviewed (Date and Initial)	U.S. Postal Service For Regional Use Only																							
<p>Instructions: A. Prepare separate forms for each dispatch point at which vehicles are based, such as stations, branches, etc. Show by dispatcher, in ascending numerical order, all postal-owned (including those as a repair shop) and all contract vehicles, including contract vehicles, that are used for postal service. Do not include vehicles that are not used for postal service. Do not include contract vehicles for postal-owned and contract vehicles. Show contractor's name and make in remarks column for contract vehicles.</p> <p>B. Complete the form as follows:</p> <p>1. Line of appropriate color, except as noted in 2, 3, and 5.</p> <p>2. Show periods of time that one hour that the vehicle is standing idle at postal stations, mailing platforms, and postal parking lots by a break in the line for the full duration of the time.</p> <p>3. Indicate periods of time not covered by 2, during which the vehicle is not in actual use, such as each period, spring periods, or periods of the route carried on foot, by marking the line between brackets ( ) intersecting the line drawn in the remarks column. Do not mark the line between brackets ( ) for periods of time when the vehicle is not in use.</p> <p>4. Show repetitive circuit trips, such as in special delivery service, by two closely parallel lines ( ) intersecting the vehicle use line at the time of return to the dispatch point for each trip or run.</p> <p>5. Indicate periods of time when contract services performed by postal-owned or leased vehicles by comments in the "Remarks" column.</p> <p>6. Show totals in "Hours operated" and "Miles operated" columns and total number of vehicles recorded in each half-hour time square block. If entries are sub-totals, indicate in the "Remarks" column.</p>		ENLWEA, CT	8/28/97																												
VEHICLE NUMBER	CAPA	OR CITY	DR IN NO.	2400 TO 0100	0100 TO 0200	0200 TO 0300	0300 TO 0400	0400 TO 0500	0500 TO 0600	0600 TO 0700	0700 TO 0800	0800 TO 0900	0900 TO 1000	1000 TO 1100	1100 TO 1200	1200 TO 1300	1300 TO 1400	1400 TO 1500	1500 TO 1600	1600 TO 1700	1700 TO 1800	1800 TO 1900	1900 TO 2000	2000 TO 2100	2100 TO 2200	2200 TO 2300	2300 TO 2400	MILES OPERATED	REMARKS		
120025	1/2	344	110																									32	13		
121817	1/2	344	110																									6	17		
121940	1/2	340	217																									5	14		
620449	1/2	416	217																									8	134		
620192	1/2		416																									5	72		
620458	1/2	5-0	416																									5	45		
622802	1/2	22	416																									8	23		
141581	300	214	416																									2	4		
240020	300	340	416																									8	36		
240521	300	416	217																									8	120		
341260	300	21	217																									8	28		
650060	500	3	217																									8	41		
650076	500	425	217																									4	5		
650121	500	18	217																									9	51		
240101	200	X																										14	63		
240221	200	23																										14	63		
TOTALS																															

PS Form 4569, Apr. 1987

Exhibit 233.34 (p. 2)
Form 4569, Vehicle Use Plan

Form 4569, Vehicle Use Plan. Includes sections for: U.S. Postal Service Vehicle Use Plan (For Postal-Owned and Hired Vehicles), Originating Office (ENHVER, CT), Prepared By (James V.A.A.), and a detailed grid for vehicle use from 2400 to 0100 hours, including columns for route, capacity, and miles operated. Includes handwritten entries and a 'REMARKS' column with notes like 'hard for day per vehicle' and 'Miles per hour supplied'.

Exhibit 233.34 (p. 3)
Form 4569, Vehicle Use Plan

U.S. Postal Service VEHICLE USE PLAN (For Postal-Owned and Hired Vehicles)
Includes sections for Survey Date (8-10-87), Originality Office (EMILY WEBB ST James V.A.), and a detailed grid for tracking vehicle use by route and time. Includes handwritten notes like '9:15-11:45' and '9:14 hour per day per vehicle'.



**233.4 Preparing Narrative Report**

Upon completion of the survey, submit a narrative report through the MSC to the division. Also maintain a copy on file.

## 24 Driver and Supervisor Responsibilities

---

**241 General**

Our mission remains to provide expedient, quality service in the safest mode of handling and delivery. However, in accomplishing our mission managers must emphasize in their daily operations that safety is everyone's responsibility and will not be compromised.

**242 Passengers and Passenger Seats****242.1 Authorized Passengers**

Postal Service executives (e.g., PCES employees) may authorize non-Postal Service persons to ride as passengers in Postal Service-owned, -rented, or -leased vehicles *only* in situations necessary to conduct official Postal Service business. Postal service executives may not delegate this responsibility, and they should consider providing written authorization in these situations.

*Exceptions:* The Postal Inspection Service and the Office of Inspector General are exempt from this requirement.

**242.2 Passenger Seats**

All passenger seats must comply with the National Highway Traffic Safety Administration (NHTSA) Code of Federal Regulations, Section 49, Paragraphs 571.208 - Occupant Crash Protection, 571.209 - Seat Belt Assemblies, and 571.210 - Seat Belt Assembly Anchorage. The seat must be forward-facing and securely attached with a backrest, and equipped with safety belts for each authorized rider.

**243 Emergency Warning Devices and Fire Extinguishers****243.1 General**

Fire extinguishers and emergency warning device kits may be installed on (but in all cases must be carried on) motor vehicles of one ton or more used in the following services:

- a. Postal-owned motor vehicles regularly scheduled for intercity and airport runs.
- b. Postal-owned motor vehicles regularly scheduled for use as wreckers, and VMF service vehicles, as well as plant and equipment vehicles.

- c. Private, contract, or leased motor vehicle equipment operated by postal personnel or by the owner or lessor, as outlined in 243.1 a and b. Fire extinguishers and emergency warning device kits should be issued on a trip basis to drivers transferring vehicles between cities.

**Note:** For approved types of extinguishers and warning devices, see DOT Standard 125 available from:

DEPARTMENT OF TRANSPORTATION  
NHTSA  
WASHINGTON DC 20591-0001

## 243.2 Fire Extinguishers

### 243.21 Description

Fire extinguishers shall be Underwriters Laboratory or Factory Mutual approved, hand portable, multi-purpose, and dry chemical, with a minimum capacity of 10 pounds.

### 243.22 Installation

Use proper bracket(s) to secure extinguishers in such a way and location that they will be easily accessible to the driver at all times. In vehicles specified, stow fire extinguishers issued on a trip or tour basis so that they do not shift and therefore interfere with the safe operation of the vehicle, or become dangerous missiles during braking, on curves, or in an accident.

## 243.3 Four-Way Emergency Flashers

Do not use four-way emergency flashers when vehicles are legally parked or proceeding down main lines of travel. Except where it is prohibited by local ordinance, you may use emergency flashers to indicate a slow rate of travel, as well as frequent starts and stops when delivering mail to a series of curb boxes located on congested high-speed arteries. When emergency flashers are activated, the turn signal is inoperable; therefore, when maneuvering a turn, cancel the emergency flashers and activate the turn signal. The flashers should be activated when vehicle is:

- a. Double parked or improperly parked due to emergency situations, such as mechanical failure or road obstruction.
- b. Disabled and exposed to moving traffic.
- c. Being towed.
- d. Parked or stopped on a curve or in an area where visibility of other drivers is obscured.
- e. Providing mail delivery to a series of curb boxes on congested high speed arteries.

#### 243.4 **Accident Report Kits**

Item 087-H, *Accident Report Kit*, must be carried in each motor vehicle, bicycle, or other vehicle owned or leased (including drive-out agreement) by the Postal Service. The kit contains:

- a. Standard Form 91, *Operator's Report of Motor Vehicle Accident*.
- b. Pencil.
- c. Chalk.
- d. Local instructions.

### 244 **Supervisor Responsibilities**

#### 244.1 **General**

##### 244.11 **Supervisors in Charge**

All supervisors involved in the vehicular movement of mail have a responsibility for effective fleet management. At locations where fleet management supervision and radio control are absent, the vehicle operators are subject to the instructions of the postal supervisor in charge of the operation.

##### 244.12 **Dispatch Point Supervisors**

Dispatch point supervisors must exercise a continual monitoring of the vehicle operations program to ensure that drivers under their supervision are exercising proper use and care for the vehicles they operate. Dispatch point supervisors should also ensure that vehicles used are properly maintained in terms of appearance and are free of debris. Dispatch point supervisors, as well as drivers, are responsible for determining whether or not a vehicle is safe to operate. When in doubt, consult vehicle maintenance personnel.

##### 244.13 **Vehicle Operations Analysts**

Vehicle Operations Analysts (VOAs) should make a weekly check of station-based and MVO vehicles and provide a condition report to the fleet manager.

#### 244.2 **Training Newly Assigned Drivers**

##### 244.21 **General**

Our motor vehicle accident statistics indicate that postal drivers with less than two years of postal driving experience are involved in a disproportionate amount of motor vehicle accidents. The following procedures will be used by delivery managers to promote the operational efficiency of newly assigned drivers. Rules and regulations governing the policy and procedures of driver training can be found in the Handbook EL-827, *Driver Selection, Training, Testing, and Licensing*.

**244.22 Craft Orientation**

In compliance with section 715.3, *Employee and Labor Relations Manual*, craft orientation is required for all newly hired personnel, specifically newly hired personnel assigned to driving duties, or assigned to a vehicle to which the operator is unfamiliar. Procedures are outlined in Handbook P-23, *Orientation and Craft Skill Training* (currently being revised under the new identifier Handbook 701). and Management Instruction EL-830-85-7, *Driver Selection, Testing and Training Programs, and Procedures*. This training must be completed prior to assigning operators to their driving duties. All operators must receive initial driver training, which includes:

- a. Driver training orientation.
- b. Vehicle familiarization on vehicles to be operated.
- c. Controlled driving instruction using vehicles the operator is expected to operate.
- d. Written and driving end-of-training tests.

**244.23 Street Observation****244.231 Requirements**

Street observations must be conducted by VOAs, delivery services managers, and other designated personnel at least twice a year or at other times when appropriate on all motor vehicle/tractor-trailer operators and carriers as well as rural carriers, including those with less than two years postal driving experience. Observations are intended to provide awareness and to improve driving practices, thus reducing the potential for accidents. Provide training to those individuals designated the responsibility of street observation.

**244.232 Cost Comparisons**

All locations performing street supervision must conduct an analysis to determine which method of performing street supervision is most cost effective. As requirements for street observation change at a location, a new cost comparison is required. (See Exhibit 244.232.)

**244.233 Recording Observed Practices**

Include observed practices on Form 1750, *Employee Probation Evaluation Period*, during the initial 30-, 60-, and 80-day evaluation periods. Document these observations using Form 4584, *Observation of Driving Practices*. Effective street observation geared to monitoring the driving habits of postal employees will assist in the identification of problem drivers, thus reducing the possibility of accidents. The use of Form 4584 is mandatory for street observations.

**244.234 Distributing Observation Forms**

Distribute copies of Form 4584 as annotated on the bottom portion of the form. The immediate manager must complete Section C, Action Taken, sign and date the form, and send the original to the Postal Employee Development Center (PEDC) Manager. Copy 2 goes to the driver. Copy 3 goes to the driver's immediate supervisor. Copy 4 goes to the local safety manager. If the driver is a probationary driver, attach copy 4 to Form 1750 and forward to the designated postal official instead of the safety manager. Retain the forms for four years.

Exhibit 244.232

**Street Supervision Cost Comparison**

**LOCATION:**

**I. Vehicle Lease**

Instructions:

**A.** Determine the number of days per year that a Delivery Unit will require a vehicle to perform street supervision.

- 1. No. days required per year:
- 2. Daily lease cost:\*

**3. Total Cost (1x2)**

**\*Note:** cost provided by location Fleet Manager.

**II. POA**

Instructions:

**A.** Determine the number of days per year that a Delivery Unit will require a vehicle to perform street supervision. If at times the mileage rate is used then determine the number of miles required. Note: It could be a combination of both.

1. No. days per year:	_____	Miles per year:	_____
2. Daily rate:	\$6.00	Cost per mile:	\$.21
3. Sub-total (1x2)	_____	Sub-total (1x2)	_____

**Total Cost** \_\_\_\_\_

**III. Comparison**

Instructions:

**A.** Compare the cost of vehicle hire against POA and recommend the lowest cost method, which could be a combination of both at large units.

**Total Cost - Vehicle Lease** \_\_\_\_\_

**Total Cost - POA** \_\_\_\_\_

**Recommendation:**

**Approval - Customer Services:** \_\_\_\_\_

**Approval - Finance:** \_\_\_\_\_

**244.235 Action To Take Regarding Observations**

Pay immediate attention to deficiencies identified during the observation. If practical, advise operators at the scene or immediately thereafter. Present discussions with drivers in a positive tone and include the benefits to be gained from improving driving practices; that is, preserve the well-being of operators and others. If, during an observation, the driver commits no violations, commend the driver immediately at the scene and annotate that action on the Form 4584.

**244.236 Suspension of Driving Privileges**

Suspension of driving privileges may be considered, but at the very least schedule improvement training for serious violations of safe driving practices. In all instances, make the driver aware that an observation has occurred and the deficiencies, if any, were noted during the observation. Any official action taken must be in accordance with the terms of the National Agreement.

**244.24 Improvement and Refresher Driver Training**

Drivers with less than three months of postal driving experience, and those transferring from nondriving duties, must be initially evaluated collectively by all managers who are capable of providing an objective appraisal in terms of job performance, specifically driving performance at 30-, 60-, and 80-day intervals. Evaluate these drivers, as well as all other drivers with less than two years of postal driving experience, at the end of one year and two years of service. Schedule employees for driver improvement training whenever there is a significant number of driving deficiencies, a serious violation(s) of safe driving practices, or as determined by local policy. Coordinate all training with the Postal Employee Development Center. Employees previously qualified on a particular type of vehicle who have not operated that type of vehicle for a period of one year or more must receive vehicle familiarization, orientation, and refresher driver training prior to operating that type vehicle. In addition, refresher driver training is urged at the time of renewal of the OF 346, *U.S. Government Motor Vehicle Operator's Identification Card*.

**244.25 Safety Talks**

At least one of the weekly safety talks must address the problems associated with the experiences of new drivers. When possible a craft employee should make the presentation to promote employee awareness and first-hand experience.

**244.3 Work Assignments and Schedules**

Delivery and vehicle services managers should make every effort to see that newly assigned employees are familiar with routes prior to actual delivery on the route without assistance. Check the OF 346 of the employee to ensure that the individual is certified to operate the assigned vehicle. Check schedules to ensure feasibility. When possible, employees should remain in the same unit under the same manager to allow adequate observation and evaluation. However, if this is not feasible, the permanently assigned manager should obtain data regarding driver performance from managers supervising the driver. Upon receipt of each appraisal, the manager should

thoroughly evaluate input, discuss any discrepancies, then conduct an objective evaluation by completing Form 1750, *Employee Probationary Period Evaluation Report*.

## 245 **Driver Responsibility**

### 245.1 **Care and Handling of Vehicles**

#### 245.11 **General**

All drivers, including letter carriers and MVS employees, of postal-owned or leased vehicles used in the Postal Service are responsible for the proper care and handling of those vehicles while in their custody. No employees shall operate a postal-owned, leased, or privately owned automobile (POA) on official business without a valid OF 346 in their possession. MSCs will be afforded the option, in the very near future, to use computerized driver licensing systems, thus eliminating the use of OF 346 in those locations.

#### 245.12 **Repair Tag**

Drivers must check and report defect(s) requiring attention on Form 4565, *Vehicle Repair Tag*, and indicate possible trouble if known for postal-owned or leased vehicles. Drivers should provide as much descriptive information as possible to assist vehicle maintenance personnel in making proper and necessary repairs. Additionally, supervisors are required to follow instructions listed on the reverse of Form 4565. Although some repairs can be deferred until scheduled maintenance service, safety items must be corrected immediately upon identification. Call repairs into a VMF or contractor at the end of a driver's route. Do not delay reports of necessary repairs until the following morning.

#### 245.13 **Form 4703, Out of Order (Trailer Tag)**

In some cases, trailers develop defects which are reported when the vehicle is spotted for loading and unloading. All tractor drivers may not be aware that a Form 4565 has been prepared for a trailer. To eliminate the possibility of using a trailer needing repairs, the driver will attach Form 4703, *Out of Order (Trailer Tag)*, to the gladhand of air couplings of the trailer when Form 4565 is prepared. Do not use a trailer so tagged until repairs have been accomplished. Tractor drivers will keep a supply of Forms 4703 in each tractor for use when needed.

### 245.2 **Driving Practices**

#### 245.21 **Speed Limit**

Drivers of Postal Service vehicles are to obey all posted speed limits. Postal Service vehicles include postal-owned, leased, and rural route vehicles. This policy also applies to contractor-operated vehicles and carriers with drive-out agreements.

**245.22 Safety Check**

All drivers, regardless of their craft, must perform a vehicle safety check outlined in Notice 76, *Expanded Vehicle Safety Check*, and in Label 70, *Safety Check and Vehicle Dimensions*, on all vehicles (postal-owned or leased). (See Exhibit 245.22.) Carriers who lease their private vehicles to the Postal Service are not required, but are encouraged, to perform the safety check to ensure a safe, operational vehicle.

**245.23 Road Calls**

Local management must establish a standard procedure for drivers to follow when their vehicle breaks down on the route. To the extent possible, the driver should pinpoint the problem to help management determine if a replacement vehicle is needed or if the unit can be repaired on site. Important: Once drivers call in a vehicle deficiency, they must not drive the vehicle.

**245.24 Consistent Road Failures**

When drivers consistently experience road failures or mechanical difficulties, their supervisors must investigate to determine whether failures are due to vehicle defects, improper maintenance, or lack of proper driver operability. Supervisors must take corrective action based on their findings.

**245.25 Traffic Laws**

Employees driving postal vehicles must comply with state and local traffic laws at all times. Traffic violations are the responsibility of the driver. Postal vehicles have no special right-of-way over private vehicles.

**245.26 Seat Belts**

Any employee (except rural carriers) operating a postal-owned, leased, or privately owned (used during official business) vehicle must use a seat belt any time the vehicle is in motion. Refer to Handbook EL-801, *Supervisor's Safety Handbook*. Rural carriers must use seat belts in accordance with Handbook M-37, *Rural Delivery Carrier's Duties and Responsibilities*.

**245.27 Parking and Securing Vehicle**

Whenever a driver leaves the vehicle, the vehicle must be parked. When parking, place vehicles with automatic transmissions in the *park* position (manual transmissions should be placed in gear), turn off the ignition, and remove the key. The hand parking brake must be engaged and the front wheels turned toward the curb on a flat surface or when the vehicle is facing downhill. If the vehicle is parked facing uphill, the front wheels should be turned away from the curb. Lock the vehicle if it will be out of sight of the driver.



Exhibit 245.22  
**Notice 76 and Label 70**

**U.S. Postal Service**

**Expanded Vehicle Safety Check**

1. Look under body for oil and water leaks.
2. Inspect two front tires for inflation and wear.
3. Check hood latches.
4. Check front fender for body damage.
5. Check left side for body damage.
6. Check left door lock.
7. Check for rear end leaks.
8. Check rear tires for inflation and wear.
9. Check rear for body damage.
10. Check rear door lock.
11. Check right side for body damage.
12. Check right door lock.
13. Open door and move into driving position.
14. Start engine (if temperature is 15°F or below).
15. With assistance - adjust pot-lid and left front mirror.
16. With assistance - check headlights, tail lights, brake lights, 4-way flashers, and directional signals, front and rear.
17. Adjust right side rear view mirror.
18. Adjust center rear view mirror.
19. Check steering wheel play.
20. Check accident report kit.
21. Check window locks.
22. Check windshield wipers and washer.
23. Check horn.
24. Check gauges (gas gauge requires 30 seconds for "warm-up").
25. Check foot brake (no more than 2 inches free play).
26. Check hand brake.
27. Check seat belt and fasten.

**Note:** This check list has been programmed to take the driver in a logical sequence around the RHD vehicle with a minimum of lost motion. For LHD vehicles - work from right side to rear to left side beginning at item 5. Items 15 and 16 - if no assistance readily available, handle personally.

**See Additional Instructions On Reverse**  
 Notice 76, April 1987

**Instructions**

Check items shown on other side on the initial use of each vehicle each day.

Report deficiencies, body damage, or inoperable items to your supervisor using Form 4565, Vehicle Repair Tag, so the condition can be corrected or another vehicle may be provided.

Proceed to your first assignment if there are no vehicle deficiencies.

Reverse of Notice 76

**DIRECTIONS:** Peel label from backing. Use peel off numbers below to insert vehicle height data. Apply to clean dry surface. Rub down smoothly.

**SAFETY CHECK BEFORE OPERATING VEHICLE**

Before operating this vehicle, report any deficiencies to your supervisor on Form 4565, Vehicle Repair Tag.

Check hood latches.

Check all tires.

Check for body and fender damage.

Check under vehicle for oil, grease, or water leaks.

Check oil gauge, gas gauge, ammeter, and air brake pressure gauge, if so equipped.

Check rear view mirrors and adjust.

Check pot lid mirror and adjust.

Check windshield wiper and horn.

Check steering for excessive play.

Check service and parking brakes.

Check all lights including signal devices.

Check accident report kit.

Check safety belts. Fasten before driving.

**ALWAYS LOOK BEFORE BACKING**

**DRIVE SAFELY**

**Label 70, Sept. 1988**

**Vehicle Height** \_\_\_\_\_ **ft.** \_\_\_\_\_ **in.**

**Check Your Driving Habits**

**0 1 2 3 4 5 6 7 8 9 10 11**

**0 1 2 3 4 5 6 7 8 9 10 11**

**245.28 Protection of Mail in Vehicles**

Protect the mail at all times. Keep the rear vehicle door locked, except when loading or unloading the vehicle. For vehicles with separate driver and cargo compartments, only working mail should be kept in the driver's compartment while performing delivery and collection duties. Interior cargo doors (if any) may be kept in the "open" position to accommodate authorized passengers being transported in auxiliary seating, operator use of cargo area windows (if any), or to aid airflow. However, drivers must consider the nature of mail or equipment being transported and use good judgment in deciding when an open internal door is suitable and will not interfere with the safety of vehicle operations. Internal cargo doors must be closed and locked when the vehicle is parked. Do not leave mail in an unlocked truck, even at a mail platform, unless opened door(s) of the vehicle are in full view and can be reached quickly if a theft is attempted. To prevent delay or loss of mail, check vehicles carefully before completing the assignment to ensure that mail has not been concealed or has not slipped into crevices. Supervisors must frequently inspect all postal-owned or -leased vehicles (including vehicles leased by employees or used in drive-out agreements) to prevent delay and loss of mail. In particular, leased vehicles must be inspected carefully for mail or postal property prior to their return to the lessor at the conclusion of the lease.

**245.3 Accident Procedures**

The following instructions are to be carried out by the driver of any vehicle involved in an accident, regardless of the extent of the injury or damage, and whether or not other parties involved state that no claim will be filed.

- a. Stop at the scene.
- b. Safeguard the scene against further accidents.
- c. Aid or assist any injured person.
- d. Safeguard the mail.
- e. Report the accident immediately in accordance with local instructions.
- f. Provide other driver(s) and police with any information required by law. Do not make any statement admitting personal or government liability or criminal negligence or attempt to negotiate an agreement or settlement with anyone.
- g. Obtain names, addresses, and telephone numbers of any injured persons. (Note the extent of visible or claimed injury.)
- h. Obtain the names, addresses, and telephone numbers of the owners or drivers of any vehicles or property damaged. Note the extent of visible damage.
- i. Obtain the names, addresses, and telephone numbers of any witnesses.
- j. Mark on pavement with chalk the positions of vehicle wheels, objects, or persons involved in the accident.

- k. Complete SF 91, *Operator's Report of Motor Vehicle Accident*, and submit it to your immediate supervisor before going off duty on the day of the accident.
- l. Notify your office in accordance with local instructions. For your protection, report all accidents in which you are involved while operating any vehicle on official business.

#### 245.4 **Form 4570, Vehicle Time Record**

##### 245.41 **General**

Document on Form 4570 all vehicle use, including postal-owned, leased, GSA, rental, and those obtained under Article 40, Section 3, of the National Agreement (including administrative vehicles). Form 4570 is a tool for determining the use of a particular vehicle; therefore, the importance of this form should not be undermined. Supervisors and managers should make use of periodic staff meetings to ensure that employees are aware of the requirement to use this form and to complete it properly. Additionally, a message stating that a Form 4570 must be completed in its entirety for each period that a vehicle is in use should be posted in the vicinity of the time clock and the card rack housing the forms, as well as posted on available bulletin boards. For non-mail-hauling vehicles, Form 4570 should be placed in the vehicle to ensure documentation by the operator. In addition, Forms 4570 for vehicles assigned to specific routes or runs must include, on the top of both sides of the form, approved mileage and fueling days on letter delivery routes and collection runs, and must be recorded in tenths of a mile.

##### 245.42 **Completing Form 4570**

Employees using vehicles must provide the following entries by use of recording devices or equipment, whenever practical.

- a. Date of use.
- b. Name of driver.
- c. Beginning and ending odometer readings.
- d. Beginning and ending times.
- e. Route or run number.

##### 245.43 **Frequency for Completing Form 4570**

Prepare a new Form 4570 at the beginning of each A/P for postal-owned, leased, rural route, and drive-out agreement vehicles. Complete data on both sides required at the heading of the form, that is, make/model code, vehicle number, and odometer reading as shown on Form 4570 at the close of the previous A/P in the space provided on the reverse of the form.

##### 245.44 **Computing Form 4570**

##### 245.441 **Postal-Owned Vehicles**

Postal-owned vehicles are those which are assigned a 7-digit vehicle identification number. The supervisor, or designated employee, must compute, on a daily basis, the total daily miles and the total number of hours

the vehicle is used. This is determined from the beginning and ending mileage and the clock rings. For nondelivery vehicles, the designated employee will evaluate miles and hours driven to ensure maximum utilization. Approved mileage for routes or runs not assigned a vehicle must be readily accessible to drivers and persons responsible for reviewing the forms. Entries on Forms 4570 must be reviewed and compared to the approved mileage on a daily basis. Discuss unauthorized deviations to approved mileage with the driver at the earliest practical time. All deviations must be noted and briefly explained on Form 4570.

245.442 **Non-Postal-Owned Vehicles—Rural Carriers**

Forms 4570 covering vehicles obtained under equipment allowance will cover a two-week payroll period.

245.443 **Postal Trailers**

Clock rings are not required on Form 4570. Credit one eight-hour day if the trailer is in service in accordance with contract agreement.

245.444 **Leased Vehicle Hire**

Prepare a separate Form 4570 for each vehicle used under hourly, daily, or weekly rate vehicle lease contracts, and for vehicles furnished by special delivery messengers under equipment maintenance allowance. Clock rings indicating beginning and ending periods of vehicle use shall be made by drivers who will also enter their names, current dates, and routes or run numbers if required. Non-use days must be identified as inoperable days, inactive days, and so forth. Diagonally clip or color code the upper left corner of Form 4570 to identify contract vehicles. Enter total hours use each day for hourly rate vehicles. Do not include lunch, swing, and standing time in vehicle use periods. Entries on Forms 4570 may be handwritten when time clocks are not available. Take care to use the front side of the form first. When more than one Form 4570 is needed for a vehicle during a reporting period, transfer the totals from the previous card to the new one. Identify each card as follows: Card 1 of 3, 2 of 3, and so forth. Once each quarter, take a sampling of the total daily hours and miles of vehicle lease use for daily or weekly rate vehicles. During one week of the first A/P of the quarter, enter total hours of use each day of the week for daily or weekly rate vehicles. Determine the average use per day by hours and tenths. Multiply by the used days in each period to develop the total hours. Enter this total on the applicable Form 8048, *Vehicle Hire*, for each period of the quarters.

Forms 4570 covering hourly and daily vehicle hire contracts will run for one postal A/P. Forms 4570 covering vehicles obtained under equipment maintenance allowance will cover a two-week payroll period. Summarize Forms 4570 for leased vehicles on Form 1804-B. At locations where a contractor has more than one vehicle, if requested the Postal Service will furnish information showing service covered. Summarize vehicle lease for special delivery messengers on Form 1804-C *Postmasters Certification of SDM Equipment Maintenance*. Show daily entries on Form 4570 in hours and tenths of hours. Show the totals to the nearest whole hour on the bottom of Form 4570 at the end of each A/P.

**245.45 Totalling Form 4570**

At the end of each A/P, total Form 4570 and insert data required on the bottom of the form. Include ending odometer reading. When more than one Form 4570 is required for a vehicle during the period, the total shown on the reverse of the last form used shall cover all hours and miles operated during the period. Total all days used, inoperable days, and all inactive days and enter in the appropriate box. Do not count Sundays and holidays in days used, inoperable days, or inactive days for postal-owned vehicles. A designated supervisor at each dispatch location shall review and approve completed Forms 4570. (Note: Form 4570 was revised to provide space for inoperable days.)

**245.46 Automated Vehicle Time Recording Systems**

When available, use automated vehicle time recording systems instead of the Form 4570, *Vehicle Time Record*, for postal-owned vehicles. Automated systems will use an electronic badge reader that collects employee, route, time, and mileage data from driver input. Drivers will use their assigned badges to enter employee and vehicle information into an electronic badge reader. Drivers enter operation number, route number, and odometer reading by responding to badge reader prompts. Automated recording systems will produce reports that parallel the completed Form 4570. The Office of Fleet Management must approve automated recording systems.

**246 Driver Awards and Contests**

Information concerning driver awards and contests can be found in section 842.2, *Employee & Labor Relations Manual (ELM)*.

## 25 Guidelines for Using Contract or Postal Vehicle for Transportation Service

---

**251 Types of Service To Be Compared**

See Article 32, National Agreement. Service changes from Postal Vehicle Service (PVS) to Highway Contract, or vice versa, will not be made without the express consent of the Operations Group, Headquarters.

**252 Cost Comparison Features**

For cost comparison, prepare Form 5505, *Cost Evaluation Postal Vehicle Service vs. Contract Service*. Where data is collected that is not defined on the form, attach the necessary information to Form 5505.

## 253 Frequency of Service Symbols

### 253.1 Frequency Symbols for Days of the Week

The seven days of the week have been assigned numbers to represent the frequency of motor vehicle service. Listed below are the numeric characters:

- 1 – Monday
- 2 – Tuesday
- 3 – Wednesday
- 4 – Thursday
- 5 – Friday
- 6 – Saturday
- 7 – Sunday

### 253.2 Frequency Symbols for Holidays and Exceptions

#### 253.21 Service Symbols for Holidays Only

Alphabetic characters have been assigned to represent the frequency of motor vehicle service before, during, and after holidays. See Exhibit 253.21 for a listing of alpha characters.

#### 253.22 Symbols for Exceptional Service

The letter “X” and the number “9” have been selected to represent exceptions to the frequency of motor vehicle service. Listed below are exception symbols:

- X – When used before numeric symbols indicates Daily except (i.e. X6 Daily except Saturday).
- X – When used after numeric symbols indicates that the trip will operate on that day except when a holiday falls on that day (i.e. 6X Saturday service except when a holiday falls on Saturday).
- 9 – Frequency not describable by symbol, see note in schedule.

### 253.3 Number and Sequence of Service Symbols

To determine the frequency of a particular trip, use both the alpha and numeric character. Each character has the same meaning whether used alone or in combination with other characters. Up to two alpha characters are allowed in a frequency, but when two appear, they must be the same. Numeric characters are shown in ascending sequence. See examples listed below for the sequence of service symbols:

- 7 – Sunday Only
- X7 – Daily Except Sunday
- 67 – Saturday & Sunday Only
- X67 – Daily Except Saturday & Sunday
- B67 – Holidays, Saturday & Sunday Only
- K167 – Daily Except Holidays, Monday, Saturday, & Sunday

**Note:** Absence of a symbol denotes daily.

Exhibit 253.21

**Service Symbols for Holidays Only**

<b>(Only)</b>	<b>(Daily Except)</b>
A – Day before holiday	J
B – Holiday	K
C – Days after holiday	L
D – Days before holidays & holidays	M
E – Holidays & days after holidays	N
F – Days before holidays other than Martin Luther King, Jr.'s Birthday, Washington's Birthday, Columbus Day, & Veterans Day	P
G – Holidays other than Martin Luther King, Jr.'s Birthday, Washington's Birthday, Columbus Day, & Veterans Day	Q
H – Days after holidays other than Martin Luther King, Jr.'s Birthday, Washington's Birthday, Columbus Day, & Veterans Day	R
O – Days before holidays other than Martin Luther King, Jr.'s Birthday, Washington's Birthday, Memorial Day, Columbus Day, & Veterans Day	V
S – Holidays other than Martin Luther King, Jr.'s Birthday, Washington's Birthday, Columbus Day, Memorial Day, & Veterans Day	W
T – Days after holidays other than Martin Luther King, Jr.'s Birthday, Washington's Birthday, Memorial Day, Columbus Day, & Veterans Day	Y
U – Days before holidays other than Martin Luther King, Jr.'s Birthday, Washington's Birthday, Memorial Day, Labor Day, Columbus Day, & Veterans Day	Z
AA – Holidays other than Martin Luther King, Jr.'s Birthday Washington's Birthday, Columbus Day Memorial Day, Labor Day, & Veterans Day	JJ
BB – Days after holidays other than Martin Luther King, Jr.'s Birthday, Washington's Birthday, Memorial Day, Labor Day, Columbus Day, & Veterans Day	KK
CC – Martin Luther King, Jr.'s Birthday, Washington's Birthday, Columbus Day, & Veterans Day	LL
DD – Martin Luther King, Jr.'s Birthday, Washington's Birthday, Columbus Day, Memorial Day, & Veterans Day	MM
EE – Martin Luther King, Jr.'s Birthday, Washington's Birthday, Columbus Day, Labor Day, Memorial Day, & Veterans Day	NN
FF – December 24 and 31	PP
GG – January 1 and December 25	QQ
HH – Two days before holidays	RR
OO – Two days after holidays	VV
SS – Daily except days before holidays other than Washington's Birthday, Columbus Day, & Veterans Day	WW
TT – Daily except holidays other than Washington's Birthday, Columbus Day, & Veterans Day	YY
UU – Daily except days after holidays other than Washington's Birthday, Columbus Day, & Veterans Day	ZZ

## 254 **Perpetual Frequencies**

### 254.1 **To Compute Basic Rate Per Mile**

See Exhibit 254.1 for a listing of perpetual frequencies to be used to compute the basic rate per mile. The perpetual frequencies include all legal public holidays. The observance date or day of month will be as follows:

New Year's Day — January 1

Martin Luther King, Jr.'s Birthday — third Monday in January

Presidents Day/Washington's Birthday — third Monday in February

Memorial Day — last Monday in May

Independence Day — July 4

Labor Day — first Monday in September

Columbus Day — second Monday in October

Veterans Day — November 11

Thanksgiving Day — fourth Thursday in November

Christmas Day — December 25

### 254.2 **To Compute Contract Service Payment**

The perpetual frequencies used to compute payments for contract service are based on the premise that Monday after a Sunday holiday is the holiday. For example, the frequency "Monday Holidays" would mean that service would be provided on all holidays which actually fell on Monday and also on all holidays which fell on Sunday but which are observed on Monday. When a contract calls for service to be omitted on holidays, the contractor will omit service on Monday following a holiday falling on Sunday.



Exhibit 254.1 (p. 1)

**Perpetual Frequencies**

<b>Definition</b>	<b>Trips Per Annum</b>
<b>The following Perpetual Frequencies include ten (10) legal public holidays. The observance date or day of month will be as follows:</b>	
New Year's Day, January 1	1.00
Martin Luther King, Jr.'s Birthday, third Monday in January	1.00
Washington's Birthday, third Monday in February	1.00
Memorial Day, last Monday in May	1.00
Independence Day, July 4	1.00
Labor Day, first Monday in September	1.00
Columbus Day, second Monday in October	1.00
Veterans Day, November 11	1.00
Thanksgiving Day, fourth Thursday in November	1.00
Christmas Day, December 25	1.00
*****	
Saturday or Tuesday or Wednesday or Friday holidays	.57
Thursday holidays	1.57
December 24 and 31	2.00
January 1 and December 25	2.00
Washington's Birthday, Columbus Day, and Veterans Day	3.00
Holidays except Monday holidays	3.86
Days before holidays other than Monday holidays	3.86
Martin Luther King, Jr.'s Birthday, Washington's Birthday, Columbus Day, and Veterans Day	4.00
Days before holidays other than Martin Luther King, Jr.'s Birthday, Washington's Birthday, Memorial Day, Labor Day, Columbus Day, and Veterans Day	4.00
Holidays other than Martin Luther King, Jr.'s Birthday, Washington's Birthday, Memorial Day, Labor Day, Columbus Day, and Veterans Day	4.00

Exhibit 254.1 (p. 2)

**Perpetual Frequencies**

<b>Definition</b>	<b>Trips Per Annum</b>
Days after holidays other than Martin Luther King, Jr.'s Birthday, Washington's Birthday, Memorial Day, Labor Day, Columbus Day, and Veterans Day	4.00
Washington's Birthday, Memorial Day, Columbus Day, and Veterans Day	4.00
Days before holidays other than Washington's Birthday, Memorial Day, Labor Day, Columbus Day, and Veterans Day	5.00
Holidays other than Washington's Birthday, Memorial Day, Columbus Day, and Veterans Day	5.00
Days after holidays other than Washington's Birthday, Memorial Day, Labor Day, Columbus Day, and Veterans Day	5.00
Martin Luther King, Jr.'s Birthday, Washington's Birthday, Memorial Day, Columbus Day, and Veterans Day	5.00
Days before holidays other than Martin Luther King, Jr.'s Birthday, Washington's Birthday, Memorial Day, Columbus Day, and Veterans Day	5.00
Holidays other than Martin Luther King, Jr.'s Birthday, Washington's Birthday, Memorial Day, Columbus Day, and Veterans Day	5.00
Days after holidays other than Martin Luther King, Jr.'s Birthday, Washington's Birthday, Memorial Day, Columbus Day, and Veterans Day	5.00
Washington's Birthday, Memorial Day, Labor Day, Columbus Day, and Veterans Day	5.00
Days before holidays other than Washington's Birthday, Memorial Day, Columbus Day, and Veterans Day	6.00
Holidays other than Washington's Birthday, Memorial Day, Columbus Day, and Veterans Day	6.00
Days after holidays other than Washington's Birthday, Memorial Day, Columbus Day, and Veterans Day	6.00
Martin Luther King, Jr.'s Birthday, Washington's Birthday, Memorial Day, Labor Day, Columbus Day, and Veterans Day	6.00
Days before holidays other than Martin Luther King, Jr.'s Birthday, Washington's Birthday, Columbus Day, and Veterans Day	6.00

Exhibit 254.1 (p. 3)

**Perpetual Frequencies**

<b>Definition</b>	<b>Trips Per Annum</b>
Holidays other than Martin Luther King, Jr.'s Birthday, Washington's Birthday, Columbus Day, and Veterans Day	6.00
Days after holidays other than Martin Luther King, Jr.'s Birthday, Washington's Birthday, Columbus Day, and Veterans Day	6.00
Monday holidays	6.14
Days before holidays other than Washington's Birthday, Columbus Day, and Veterans Day	7.00
Holidays other than Washington's Birthday, Columbus Day, and Veterans Day	7.00
Days after holidays other than Washington's Birthday, Columbus Day, and Veterans Day	7.00
Holidays	10.00
Days before holidays	10.00
Days after holidays	10.00
Two days before holidays	10.00
Two days after holidays	10.00
Days before holidays and holidays	20.00
Holidays and day after holidays	20.00
Monday except Monday holidays	46.04
Sunday except Sunday before Monday holidays	46.04
Monday except Monday holidays other than Martin Luther King, Jr.'s Birthday	47.04
Washington's Birthday	47.04
or Columbus Day	47.04
or Memorial Day	47.04
Any combination of two of above holidays	48.04
Any combination of three of above holidays	48.04
Any combination of four of above holidays	50.04

Exhibit 254.1 (p. 4)

**Perpetual Frequencies**

<b>Definition</b>	<b>Trips Per Annum</b>
Sunday except Sunday before Monday holidays other than Martin Luther King, Jr.'s Birthday, or Washington's Birthday or Columbus Day or Memorial Day Any combination of two of above holidays Any combination of three of above holidays Any combination of four of above holidays	47.04 47.04 47.04 47.04 48.04 49.04 50.04
Thursday except Thursday holidays	50.61
Sunday except Sunday holidays (operates every Sunday except when a holiday actually falls on Sunday)	51.61
Tuesday except Tuesday holidays	51.61
Wednesday except Wednesday holidays	51.61
Friday except Friday holidays	51.61
Saturday except Saturday holidays	51.61
Monday	52.18
Tuesday	52.18
Wednesday	52.18
Thursday	52.18
Friday	52.18
Saturday	52.18
Sunday	52.18

Exhibit 254.1 (p. 5)

**Perpetual Frequencies**

<b>Definition</b>	<b>Trips Per Annum</b>
Mondays and days after holidays except days after Monday holidays	56.04
Sundays and holidays except Monday holidays	56.04
Sundays and days before holidays	56.04
Mondays and holidays	56.04
Sundays and holidays except Sundays before Monday holidays	56.04
Saturdays and holidays except Martin Luther King, Jr.'s Birthday, Washington's Birthday, Memorial Day, Columbus Day, and Veterans Day	56.61
-Except any four of above	57.61
-Except any three of above	58.61
-Except any two of above	58.61
-Except any one of above	60.61
Saturdays and holidays	61.61
Sundays and holidays except Martin Luther King, Jr.'s Birthday, Washington's Birthday, Memorial Day, Columbus Day, and Veterans Day	57.18
-Except any four of above	58.18
-Except any three of above	59.18
-Except any two of above	60.18
-Except any one of above	61.18
Sundays and holidays	62.18
Mondays and days after holidays except days after Saturday holidays	61.61
Sundays and holidays except Saturday holidays	61.61

Exhibit 254.1 (p. 6)

**Perpetual Frequencies**

<b>Definition</b>	<b>Trips Per Annum</b>
Mondays and days after holidays	62.18
Saturdays and days before holidays	62.18
Sundays, Mondays, and holidays except Martin Luther King, Jr.'s Birthday, Washington's Birthday, Memorial Day, Columbus Day, and Veterans Day	103.22
–Except any four of above	104.22
–Except any three of above	105.22
–Except any two of above	106.22
–Except any one of above	107.22
Sundays, Mondays, and holidays	108.22
Sundays, Saturdays, and holidays except Martin Luther King, Jr.'s Birthday, Washington's Birthday, Memorial Day, Columbus Day, and Veterans Day	108.79
–Except any four of above	109.79
–Except any three of above	110.79
–Except any two of above	111.79
–Except any one of above	112.79
Fridays, Saturdays, and holidays	113.22
Sundays, Saturdays, and holidays	113.79
Sundays, Mondays, and days after holidays	113.79
Sundays, Mondays, holidays, and days before holidays	117.65
Sundays, Mondays, holidays, and days after holidays	117.65
Saturdays, Sundays, Mondays, holidays, and days after holidays	169.83
Daily except Saturdays, Sundays, Mondays, holidays, and days after holidays	195.42
Daily except Fridays, Saturdays, Sundays, and holidays	199.85

Exhibit 254.1 (p. 7)

**Perpetual Frequencies**

<b>Definition</b>	<b>Trips Per Annum</b>
Daily except Saturdays, Sundays, Mondays, and holidays	205.42
Daily except Saturdays, Sundays, holidays, and days before holidays	247.60
Daily except Sundays, Mondays, holidays, and days after holidays	247.60
Daily except Saturdays, Sundays, holidays, and December 24 and 31	249.46
Daily except Sundays, Mondays, and days after holidays	251.46
Daily except Fridays, Saturdays, and days before holidays	251.46
Daily except Saturdays, Sundays, and holidays	251.46
Daily except Fridays, Saturdays, and holidays	252.03
Daily except Sundays, Saturdays, and holidays other than Martin Luther King, Jr.'s Birthday, Washington's Birthday, Memorial Day, Columbus Day, and Veterans Day	256.46
-Other than any four of the above	255.46
-Other than any three of above	254.46
-Other than any two of above	253.46
-Other than any one of above	252.46
Daily except Sundays, Mondays, and holidays	257.03
Daily except Sundays, Mondays, and holidays other than Veterans Day	258.03
Daily except Saturdays, Sundays, and days before holidays	257.03
Daily except Saturdays, Sundays, January 1, and December 25	259.45
Daily except Saturday and Sunday	260.89
Daily except Sundays and Mondays	260.89
Daily except Sundays, holidays, and days after holidays	293.64

Exhibit 254.1 (p. 8)

**Perpetual Frequencies**

<b>Definition</b>	<b>Trips Per Annum</b>
Daily except Mondays and days after holidays	303.07
Daily except Saturdays and days before holidays	303.07
Daily except Sundays and holidays	303.07
Daily except Sundays and days after holidays	303.64
Daily except Sundays and holidays except Saturday holidays	303.64
Daily except Saturdays and holidays	303.64
Daily except Sundays and holidays other than Martin Luther King, Jr.'s, Birthday, Washington's Birthday, Memorial Day, Columbus Day, and Veterans Day	308.07
–Any four of the above	307.07
–Any three of above	306.07
–Any two of above	305.07
–Any one of above	304.07
Daily except Mondays and holidays	309.21
Daily except (Monday, Tuesday, Wednesday, Thursday, Friday, Saturday, Sunday)	313.07
Daily except days before holidays and holidays	345.25
Daily except days before holidays	345.25
Daily except days before holidays	355.25
Daily except holidays	355.25
Daily except days after holidays	355.25
Daily except two days before holidays	355.25
Daily except two days after holidays	355.25
Daily except days before holidays other than Washington's Birthday, Columbus Day, and Veterans Day	358.25



Exhibit 254.1 (p. 9)

**Perpetual Frequencies**

<b>Definition</b>	<b>Trips Per Annum</b>
Daily except days before holidays other than Martin Luther King, Jr.'s Birthday, Washington's Birthday, Columbus Day, and Veterans Day	359.25
Daily except holidays other than Washington's Birthday, Columbus Day, and Veterans Day	358.25
Daily except holidays other than Martin Luther King, Jr.'s Birthday, Washington's Birthday, Columbus Day, and Veterans Day	359.25
Daily except days after holidays other than Washington's Birthday, Columbus Day, and Veterans Day	358.25
Daily except days after holidays other than Martin Luther King, Jr.'s Birthday, Washington's Birthday, Columbus Day, and Veterans Day	359.25
Daily except days before holidays other than Washington's Birthday, Memorial Day, Columbus Day, and Veterans Day	359.25
Daily except days before holidays other than Martin Luther King, Jr.'s Birthday, Washington's Birthday, Memorial Day, Columbus Day, and Veterans Day	360.25
Daily except holidays other than Washington's Birthday, Memorial Day, Columbus Day, and Veterans Day	359.25
Daily except holidays other than Martin Luther King, Jr.'s Birthday, Washington's Birthday, Memorial Day, Columbus Day, and Veterans Day	360.25
Daily except days after holidays other than Washington's Birthday, Memorial Day, Columbus Day, and Veterans Day	359.25
Daily except days after holidays other than Martin Luther King, Jr.'s Birthday, Washington's Birthday, Memorial Day, Columbus Day, and Veterans Day	360.25
Daily except Washington's Birthday, Memorial Day, Labor Day, Columbus Day, and Veterans Day	360.25
Daily except Martin Luther King, Jr.'s Birthday, Washington's Birthday, Memorial Day, Labor Day, Columbus Day, and Veterans Day	359.25
Daily except days before holidays other than Martin Luther King, Jr.'s Birthday, Washington's Birthday, Memorial Day, Labor Day, Columbus Day, and Veterans Day	361.25

Exhibit 254.1 (p. 10)

**Perpetual Frequencies**

<b>Definition</b>	<b>Trips Per Annum</b>
Daily except days before holidays other than Washington's Birthday, Memorial Day, Labor Day, Columbus Day, and Veterans Day	360.25
Daily except holidays other than Washington's Birthday, Memorial Day, Labor Day, Columbus Day, and Veterans Day	360.25
Daily except holidays other than Martin Luther King, Jr.'s Birthday, Washington's Birthday, Memorial Day, Labor Day, Columbus Day, and Veterans Day	361.25
Daily except days after holidays other than Washington's Birthday, Memorial Day, Labor Day, Columbus Day, and Veterans Day	360.25
Daily except days after holidays other than Martin Luther King, Jr.'s Birthday, Washington's Birthday, Memorial Day, Labor Day, Columbus Day, and Veterans Day	361.25
Daily except Martin Luther King, Jr.'s Birthday, Washington's Birthday, Memorial Day, Columbus Day, and Veterans Day	360.25
Daily except Washington's Birthday, Memorial Day, Columbus Day, and Veterans Day	361.25
Daily except Martin Luther King, Jr.'s Birthday, Washington's Birthday, Columbus Day, and Veterans Day	361.25
Daily except Washington's Birthday, Columbus Day, and Veterans Day	362.25
Daily except December 24 and 31	363.25
Daily except January 1 and December 25	363.25
Daily	365.25
<p>The perpetual frequencies used to compute payments for contract service are based on the premise that the Monday after a Sunday holiday is the holiday. For example, the frequency "Monday holidays" would mean that service would be provided on all holidays that actually fall on Monday and also on all holidays that fall on Sunday but are observed on Monday. When a contract calls for service to be omitted on holidays, we expect the contractor to omit service on Monday following a holiday falling on Sunday.</p>	

## 26 Motor Vehicle Accident Investigation

---

### 261 General

#### 261.1 Scope

This section involves every aspect of vehicle accident investigation, except for the handling of tort claims filed against the Postal Service. Tort claims procedures related to accident investigation are covered in the *Administrative Support Manual*, subchapter 250, and Handbook PO-702, *Accident Investigations — Tort Claims*.

#### 261.2 Responsibility

##### 261.21 Postal Service

The Postal Service will investigate motor vehicle accidents of any kind that involve its operations, with particular emphasis on those in which a tort claim may be filed by or against the Postal Service.

##### 261.22 Postmasters and Installation Managers

Postmasters and installation managers are responsible for the on-site investigation of all motor vehicle accidents occurring within their premises or operations and involving employees or Postal Service–owned or –leased vehicles.

##### 261.23 Employee's Immediate Supervisor

The immediate supervisor of a driver involved in a motor vehicle accident while on-the-clock and/or in a status covered by the Federal Employees Compensation Act (FECA) must compile or obtain complete accident data. The related tasks include but are not limited to the following:

- a. Review Standard Form (SF) 91, *Operator's Report of Motor Vehicle Accident*.  
*Note:* Postal Service drivers must complete SF 91 in its entirety at the scene of a vehicle accident, except when precluded by medical, safety, or security concerns.
- b. Review PS Form 1700, *Accident Investigation Worksheet*, completed by the accident investigator.
- c. Discuss the accident with the driver involved.
- d. Based on the discussion with the driver and on information reported on SF 91 and PS Form 1700, complete PS Form 1769, *Accident Report* (or an authorized alternative), and forward the form (or the authorized alternative) as required.
- e. Review the driver's on-duty driving record, determine whether any corrective measures are appropriate, and initiate action as warranted.
- f. Within 24 hours of the accident, send copies of the SF 91 and PS Form 1700 to the postmaster or installation manager (or the designee). Send the original SF 91 and PS Form 1700 to the district tort claims

coordinator. Also ensure that the district tort claims coordinator receives all photographs, witness statements, and/or police reports associated with the accident. Retain copies of all submitted materials.

## 262 **Reporting Vehicle Accident Damage**

### 262.1 **Required Reporting**

#### 262.11 **Postmaster or Installation Manager**

The postmaster or installation manager (or the designee) must record the accident using PS Form 4564, *Postal Vehicle Accident Register* (or a similar softcopy record), and report to the vehicle maintenance facility (VMF) and to the district tort claims coordinator (for reporting via the Tort Claims Program) any motor vehicle accident involving the following:

- a. Injury to any person.
- b. Damage to non-Postal Service property.
- c. Damage to a Postal Service-owned or -leased vehicle or other Postal Service property.

#### 262.12 **VMF Manager**

The VMF manager (or the designee) must also record the accident using PS Form 4564 (or a similar softcopy record). Consult instructions accompanying PS Form 1769 (or authorized alternative) for explanation of minor damage and normal wear-and-tear damage.

### 262.2 **Review of PS Form 4564**

The VMF manager (or the designee) must review PS Form 4564 (or a similar soft copy record) at least once each month and ensure that Postal Service vehicles are inspected and repaired promptly, and document repair and vehicle replacement costs in support of potential claims for damage caused by private parties to Postal Service-owned or -leased vehicles.

## 263 **Claims for Private-Party Damage to Postal Service Vehicles**

### 263.1 **Preparing Claims**

#### 263.11 **Threshold for Recovery**

When a private party damages a Postal Service-owned vehicle, or a Postal Service-leased vehicle that is under a contract making the Postal Service responsible for vehicle maintenance and repair, the VMF manager (or the designee) must promptly determine and document the cost of repairs and a temporary or permanent replacement vehicle. The VMF manager must provide these documented costs to the district tort claims coordinator (or the designee), who must initiate a claim for restitution when the amount of damage is estimated at \$100 or more and the accident investigation has established that the private party is at fault. (See part 264 for damage to a

Postal Service–owned or –leased vehicle caused by another government agency.)

#### 263.12 **Estimating and Documenting Repairs and Replacement**

When the Postal Service bills a private party or the private party's insurer, the supporting statement must clearly itemize and identify the following, in a manner that will allow the debtor to reasonably audit the charges:

- a. Hours of labor. For completed repairs, use actual hours of labor. Preferably, prepare a claim upon completion of a repair, since documentation of actual costs will be available. For a claim based on pending repairs, use standard estimated repair times for type of vehicle and work required.
- b. Cost of labor. For repairs performed by the VMF, use the rate for warranty reimbursement most recently published in a Postal Service *Vehicle Maintenance Bulletin*. This rate includes both direct personnel and related overhead costs. For outsourced repairs, use the actual cost of labor charged to the Postal Service and include any specific additional costs incurred in the process, such as VMF employee labor or other resources used to tow the vehicle or perform other associated tasks.
- c. Cost of parts. Use the *actual* cost of parts, including shipping costs (if any). If parts are taken from Postal Service–owned or consigned inventory, use the current cost to the Postal Service to replace the part, rather than an average figure for all on-hand parts of the particular type.
- d. Replacement costs. The entitlement to damages for loss of use varies from state to state. If you are unsure of the law in your state, consult the General Counsel's National Tort Center. If the Postal Service vehicle will be temporarily unavailable for normal scheduled use, include in the claim an amount based on the scheduled days of service lost multiplied by the daily cost of a rented or leased replacement vehicle (if any). Where permitted by law, include such replacement costs in the claim even if the Postal Service does not acquire a rental or leased vehicle, in order to cover the operational costs of repositioning other vehicles, modifying employee schedules and assignments, and similar impacts caused by the nonavailability of the vehicle. If the Postal Service vehicle was damaged so severely that it cannot be repaired, base the claim for any vehicle that is commercially available on the fair market value of the vehicle, minus the salvage value. When a Postal Service vehicle has been declared a total loss, make temporary-loss-of-use claims (where permitted by law) based on the cost of temporarily renting or leasing a replacement vehicle for a reasonable period of time.

**Note:** Some Postal Service right-hand-drive (RHD) vehicles, such as an LLV, not only are operationally critical but have unique design features and an unusually long period of expected use. As a result, the Postal Service can argue that there is no comparable commercially available vehicle that it can use to determine a fair market value. Therefore, if such a vehicle was destroyed as a result

of private-party damage, the Postal Service can argue it incurred the full cost of the vehicle's replacement at the contract price of the most recently acquired Postal Service RHD vehicle.

### 263.13 **Negotiating Settlements**

Frequently, the Postal Service must negotiate damage claims. The Postal Service negotiator must consider various factors, including locally available commercial labor rates that are below Postal Service standard, market pricing of vehicles, state laws, local insurance industry practices, disputed liability issues, etc. If a private party or its insurer disputes issues such as full liability, the standard Postal Service labor rate, the value that the Postal Service places on a vehicle, etc., the Postal Service designee pursuing the claim should conduct the negotiations in the manner that best meets the Postal Service's interest in a fair and speedy recovery. In any situation in which a particular difficulty arises over legal issues, consult the General Counsel's National Tort Center for guidance or assistance.

### 263.2 **Incomplete Collection**

If a private party fails to pay or fairly negotiate a Postal Service claim, complete PS Form 1902, *Justification for Billing Accounts Receivable*, and forward it to the San Mateo Accounting Service Center. Consult the General Counsel's National Tort Center for assistance with affirmative claims when appropriate.

### 263.3 **Acceptance of Payment**

Based on the vehicle's assigned location, the appropriate personnel — the General Counsel, the San Mateo Accounting Service Center, or the district tort claims coordinator (or the designee) — shall accept payments in full settlement of claims for damage to Postal Service-owned or -leased vehicles, including vehicle damage debt claims, execution of releases of further liability, and the negotiation of checks and drafts bearing language having the effect of releases.

### 263.4 **Adjustments to Claims**

If a claim has been calculated incorrectly and submitted to a private party, the tender of payment identifying an overstatement of damage or costs, if justified, is not considered a compromise but rather an adjustment. The General Counsel, the San Mateo Accounting Service Center, or the district tort claims coordinator (or the designee), as noted in 263.3, handles such adjustments as payment in full satisfaction of the debt.

### 263.5 **Compromise Settlements**

A compromise offer is an offer to settle a vehicle damage claim for a lesser amount that is not based on a justifiable overstatement of damage or costs. Only the General Counsel, the San Mateo Accounting Service Center, or the district tort claims coordinator (or the designee) may accept compromise offers.

**263.6 Offers in Kind**

In case of damage to Postal Service–owned vehicles wherein the private party is responsible, the private party or the designated insurer may offer to reimburse the cost of repair of the damaged vehicle.

**264 Claims for Damage Involving Other Government Agency**

Do not file a claim for damage to a postal vehicle with another government agency. The Law Department has advised: “The Comptroller General of the United States has held that the appropriation available to a Government agency may not be used to reimburse another Government agency for property damage.”

**265 Damage by Postal Employee****265.1 General**

Refer to Section 3, Article 28, National Agreement.

**265.2 Request for Counsel****265.21 Employee Action**

Postal personnel involved in accidents, while on official duty, resulting in court action will be defended in all cases, both civil and criminal. Under no circumstances should a request for counsel be made to defend the owners of contract vehicles or their drivers. When a civil action or proceeding is brought against a postal employee for property damage, personal injury, or death resulting from an accident while on official duty, the employee (or employee’s personal representative in case of death) shall deliver immediately to the official-in-charge all processes and pleadings served upon the employee or an attested true copy thereof.

**265.22 Management Action**

On receipt of the processes or pleadings, or any information on commencement of a civil action or proceeding against the employee or employee’s estate, the official-in-charge shall immediately advise the Inspection Service by telephone (section 667, ELM). When an official-in-charge receives notice that a criminal charge has been instituted against a postal employee, the official shall advise the Inspection Service and furnish them with all available papers so that they may immediately present the case to the Assistant United States Attorney.

## 266 **Claim for Damage to Leased Vehicles**

### 266.1 **Contract Obligations**

These are claims resulting from damage to leased vehicles while in postal custody and are adjudicated and paid as contractual obligations rather than tort claims. Payment may not exceed contractor's loss. When an employee causes a vehicle to be damaged, an eligible contractor may claim, and is entitled to receive, the actual cost of returning the vehicle to its condition before the damage occurred, or replacement of it with a vehicle of like age and condition, whichever amount is less. When a vehicle is continuously in postal custody for more than 24 hours, and Form 4577, *Leased Vehicle Condition Report*, indicates accident damage, management has a reason to believe it has been caused by an employee unless an investigation proves otherwise. Verify that the employee reports all damage inflicted on the contractor's vehicle so that all valid claims may be paid.

### 266.2 **Liability Not Accepted**

The Postal Service does not accept liability for damage known to have been caused by other parties, including contractors engaged by the Postal Service, such as highway contractors. Accident damage to vehicles leased on day-to-day basis without use of Form 4577 is assumed to have been caused by others unless evidence indicates otherwise. The Postal Service does not accept liability for theft, vandalism, pilferage, or damage by weather or other natural causes.

### 266.3 **Contractor's Responsibility**

#### 266.31 **Reporting Damage**

The use of Form 4577 is mandatory for all vehicle contracts and also serves to notify the postmaster that the vehicle returned has been damaged. The contractor or contracting officer's representative must notify the contractor (usually the fleet manager) or the postal employee handling vehicle lease when a vehicle has been damaged. This notice must be given at once, or in no case later than 48 hours after the return of the vehicle, in order for a claim to be considered.

#### 266.32 **Filing a Claim**

When a contractor wishes to file a claim for damage, the contractor must notify the contracting officer, in writing, within five days of the return of the vehicle. Notice may be made by filing a Standard Form 95, *Claim for Damage, Injury, or Death*, with the contracting officer, or by writing a letter of notification to the contracting officer followed by a completed SF 95. The SF 95 must be signed by the claimant. The contractor must also submit to the contracting officer any estimates, statements, or other documents to support the submitted claim.



**266.4 Authority**

The contracting officer may approve or reject the claim for damage to a contractor's vehicle under terms of the vehicle lease contract. Inform the vehicle hire contractor immediately, by telephone, confirmed by written memorandum, that an accident report has been received involving one of their vehicles.

**266.5 Criteria for Adjudication of Claims****266.51 Judgment**

These criteria are intended as guidelines, not as rigid rules. Some claims will not be clear-cut and may include conflicting statements, disputed facts, or the absence of all facts. Therefore, annotate and retain reasons for reimbursement/nonreimbursement as part of the accident file. Approving officials must exercise considerable judgment in evaluating a claim. In making a decision, they will have to consider Postal Service policy to willingly pay the claimant for actual loss caused by a postal employee.

**266.52 Claims for Less Than \$50**

Claims for less than \$50 may be approved without a formal estimate if the estimate is considered reasonable by the supervisor investigating the accident.

**266.53 Claims for \$50 Through \$100**

Claims for \$50 through \$100 may be considered if there is one estimate or paid bill submitted by a reputable garage on its letterhead. The approving officer may require another estimate when the one received appears exorbitant for the repairs indicated.

**266.54 Claims Over \$100**

Claims in excess of \$100 must be supported by repair estimates on business letterheads from two reputable garages. One of the estimates may be from the contractor's own shop. If the repair estimate is greater than the cost of replacing the vehicle with another of like condition, model, and age, the replacement cost is the maximum reasonable allowance. Incidental costs directly resulting from the damage, such as telephone calls and towing, may be considered if appropriate.

**266.55 Payment for Vehicles Being Repaired**

When a vehicle is out of service and undergoing repairs for accident damage caused by an act of negligence on behalf of a postal employee, the contractor may include in the claim the lost profit on the vehicle during the period it is out of service. Profit is the difference between the rate of pay and the total cost of operating the vehicle. Any claim for profit of more than 15 percent of the daily or hourly rate must be supported by evidence that the profit is greater than 15 percent. Allow profit only for the reasonable number of hours or days required to repair the vehicle. Use estimated repair time if available.

### 266.56 **Technical Advice**

When needed, technical advice may be sought from private sector fleet managers, automobile dealers, state and municipal authorities, or insurance companies as to wholesale or retail values of vehicles or claim handling. When repair cost appears exceptionally high or otherwise unusual, consult the fleet manager for technical advice. Note in the file the date, subject, and tenor of conversations related to the claim.

### 266.57 **Processing Claims**

#### 266.571 **Contracting Officer**

- a. Review each claim to see that it is signed, that the SF 95 is complete, and that all required reports accompany the claim.
- b. Return incomplete claims for completion.
- c. Adjudicate claims as follows:
  - (1) When a claim is approved for the full amount, complete Form 4523, *Damage Claims Certification - Hired Vehicle*.
  - (2) When a claim is denied, notify contractor, in writing, and give reasons for denial.
  - (3) When a claim is partially approved, complete Form 4523 for the amount approved and explain to contractor, in writing, reasons for lesser payment as well as appeal rights.
- d. Forward the original Form 4523 for claims approved for payment to the appropriate PDC for processing.

#### 266.572 **Claim Files**

Retain the original claim file for three years from the date of processing. When the original forms are required for processing personal injury or other damage claims, retain a copy annotated to show where the original was sent.

#### 266.573 **Mixed Claims**

If claims resulting from damage to leased vehicles in postal custody also involve damage to other property or personal injury, handle the different types of claims separately. Handle damage to other property and personal injury as tort claims according to the POM and Handbook M-19.

## 267 **Contractor's Mail Vans**

### 267.1 **Nature of Claims**

Claims covered in this part are those which result from damage to contractors' flexi-vans, trailers, or other types of mail containers while in the custody of the Postal Service under the terms of a contract with a railroad. The claims will be adjudicated and paid as contractual obligations rather than as tort claims. There is no dollar limitation placed on the amount of a damage claim that may be settled under terms of a contract. When an accident involves damage to a contractor's van, damage to other property, or personal injuries, the claims for damage to other property or personal injuries will be handled as tort claims according to the POM and Handbook M-19.

**267.2 Liability for Loss or Damage****267.21 Postal Service Responsibility**

The Postal Service is responsible for loss or damage to vans if such loss or damage was caused by an act of negligence on behalf of either a postal employee, or mail contractors, including their employees, to whom the postmaster has transferred custody and control of such vans. Unless the postmaster determines that the loss or damage was not caused by an act of negligence on behalf of either a postal employee, or mail contractors, including their employees, to whom the postmaster has transferred custody and control of such vans, it may be assumed that the loss or damage was caused by such persons.

**267.22 Contractor or Other Responsibility**

The Postal Service is not responsible for loss or damage to mail vans if such loss or damage is caused by an act of negligence of either the mail contractor, including contractor's employees, if such mail contractor is the owner of the vans, or by other third parties. The Postal Service is not responsible for loss or damage to mail vans resulting from ordinary wear and tear.

**267.3 Determining Responsibility for Damage**

To establish whether damage has occurred to a contractor's van while in the custody of the Postal Service, determine whether the loss or damage was the result of reasonable wear and tear or an act of negligence of any of the following:

- a. A postal employee.
- b. A mail contractor, or contractor's employee, to whom the postmaster has given custody and control of the vans.
- c. A third party.
- d. The mail contractor-owner of the vans (including contractor-owner's employees).

**267.4 Report of Accident**

Verify that the operator of the van (postal employee, mail contractor, or contractor's employee) prepared the SF 91 in accordance with instructions covered in Handbook M-19, *Accident Investigations - Tort Claims*, and submitted it to the contracting officer.

**267.5 Investigation by Fleet Manager**

On the basis of information on Form 5201 and SF 91, fleet manager will:

- a. Investigate to determine whether damage was a result of an act of negligence by postal employee, mail contractor, or contractor's employee, or the result of an act by a third party.
- b. Inspect the van to verify the reported damages.
- c. Estimate probable repair cost.
- d. Retain all papers pertaining to the damage, pending receipt of the claim.

**267.6 Action on Receipt of Claim**

Upon receipt of an SF 95 from the contractor, the fleet manager will:

- a. Ascertain that information on the SF 95 is consistent with that reported on Form 5201 and SF 91.
- b. Verify amount of damage claims.
- c. Prepare a statement of findings and recommendations. Send the statement to the district Procurement Services Office having jurisdiction over the applicable area, along with the original SF 95 and Form 5201, and a certification that the loss or damage was the result of reasonable wear and tear, an act of negligence on behalf of a postal employee; a mail contractor, or one of the contractor's employees, to whom the postmaster has given custody and control of the van; a third party; or the mail contractor-owner of the van or one of the contractor-owner's employees.
- d. Retain on file any other papers relating to the accident.

## 27 Cargo Loading and Control for Vehicle Movements of Mail Containers

---

**271 General**

Because of the problems of handling vast mail volumes in crowded areas and across restricted docks, containerization becomes more and more imperative. Toward this end, new containers are being developed and vehicles designed to handle new devices. Successful operation of an integrated container system requires adequate cargo control equipment and employees knowledgeable in the use of such equipment. Improper loading of containers into vehicles can do much to nullify the benefits inherent in the container operation. Damage to the mail, the containers, and the vehicles can result from poor loading.

**272 Responsibility**

Vehicle supervisors, dock supervisors, group leaders, vehicle operators, and mailhandlers must strive for safe, efficient handling and loading of containers and vehicles. Ultimately, it is the prime responsibility of the vehicle operator to ensure that the vehicle is properly loaded and the contents are securely and safely tied down with the vehicle doors secured. The remainder of this chapter delineates the available equipment containers, vehicles, and control devices and the proper methods for their use.

## 273 **Training and Equipment**

### 273.1 **Training**

Adequate training must be administered and documented on Form 2548, *Individual Training Record — Supplemental Sheet*, for all newly hired employees regarding proper loading, unloading, and securing of containers. Additionally, refresher training must also be administered and documented periodically for all personnel whose duties involve handling of containers.

### 273.2 **Equipment**

Refer to Handbook PO-502, *Container Methods*, regarding containers and materials handling equipment used in local interfacility movement.

## 274 **Elements of Good Loading**

### 274.1 **Total Vehicle Time at the Dock**

Total vehicle time at the dock is of great importance when maneuvering areas are congested and truck bays are limited. Reducing turn-around time by one-half is equivalent to doubling the number of available loading bays.

### 274.2 **Proper Weight Distribution**

Weight distribution is essential for safe and efficient vehicle operation. Heavy concentration of weight over the rear axle may cause lightening of the front axle, resulting in loss of steering control. Heavy weight on one side results in damage to springs, excessive tire wear, and steering pull (see Exhibit 274.2).

### 274.3 **Weight Limitation of Vehicle or Containers Being Loaded**

Most postal loads will not exceed the designed net payload capacity of our vehicles or containers. However, bulk mail may weigh up to 50 pounds per cubic foot and will far exceed the weight capacity of our vehicles or containers if full cubic capacity is used. Do not exceed the load carrying limit for containers or vehicles. Exceeding this weight limitation can cause broken springs, bent frames, split floor, and blown tires, as well as dangerously changing the center of gravity of the vehicle. (See Exhibit 274.3.)

### 274.4 **Securing Vehicle Loads**

#### 274.41 **Shoring Bars**

A shoring bar or hat section reinforcement must be permanently installed in the front cargo area of all 5- to 7-ton vehicles and trailers. Stack and secure sack loads to prevent shifting, either from side to side or from front to rear. Often sack loads fall against the rear door and wedge so that the doors cannot open. Secure rolling loads so that there can be no movement in transit. Above all, securely close and lock the vehicle to prevent loss of mail and accidents en route. (See Exhibit 274.2.)

Exhibit 274.2

**Proper Weight Distribution and Securing Vehicle Loads**

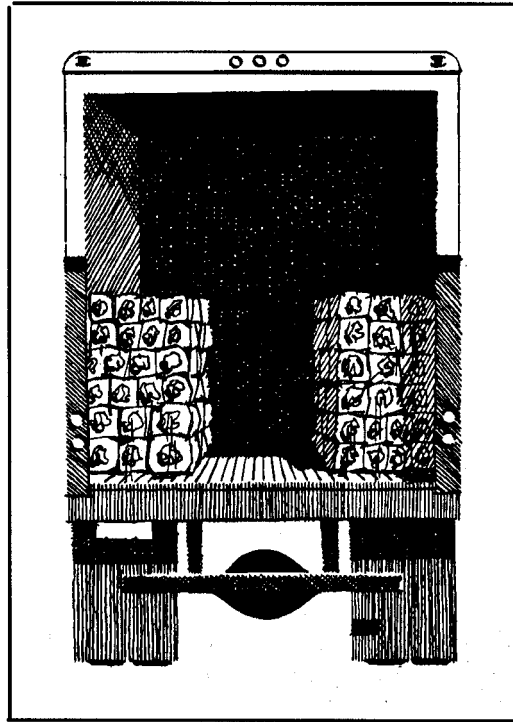

**Proper Weight Distribution**

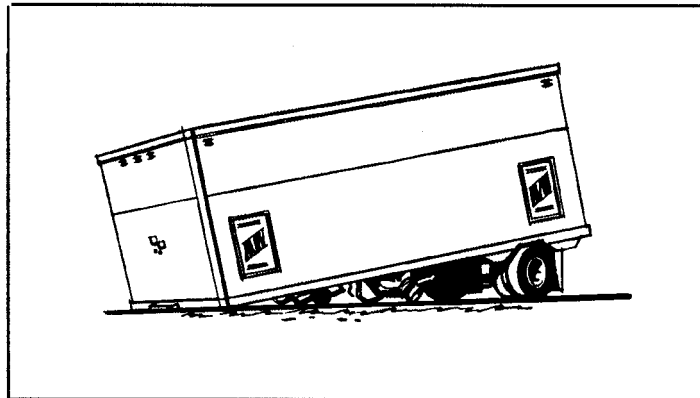

**Broken Truck**

Exhibit 274.3 (p. 1)

**Weight Limitations**

To acquaint you with other makes, models, and dimensions of vehicles in our fleet, the following chart has been entered for references.

**TRUCK CARGO CAPACITIES**



**1/4-TON, 50 CUBIC FOOT CAPACITY**

<b>Body Dimensions (Inside)</b>	<b>Inches</b>
Length (does not include mail tray space)	42
Width	57
Height	44
Door opening height	39
Bed height	25

Exhibit 274.3 (p. 2)  
**Weight Limitations**



**1/2-TON, 130 CUBIC FOOT CAPACITY**

<b>Body Dimensions (Inside)</b>	<b>Inches</b>
Length (does not include mail tray space)	62
Width	69
Height	61
Door opening height	54
Bed height	24



Exhibit 274.3 (p. 3)  
**Weight Limitations**



**1-TON, 300 CUBIC FOOT CAPACITY**

<b>Body Dimensions (Inside)*</b>	<b>Inches</b>
Approximate Dimensions	
Length	99
Width	77
Height	73
Door opening height	63
Bed height	28

Exhibit 274.3 (p. 4)  
**Weight Limitations**



**2-TON INTERMEDIATE, 493 CUBIC FOOT CAPACITY**

<b>Body Dimensions (Inside)*</b> Approximate Dimensions	<b>Inches</b>
Length	193.0
Width	86.5
Height	76.0
Door opening height	69.5
Bed height	34.0

Exhibit 274.3 (p. 5)  
**Weight Limitations**

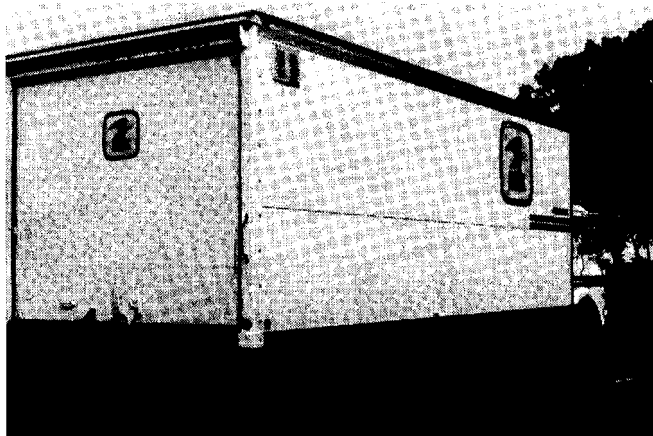

**TRAILERS**

**Body Dimensions (Inside, approximate)**

Length (Feet)	22 to 38
Width (Inches)	89
Height:	
11 foot 6 inch exterior (inches)	93
12 foot 6 inch exterior (inches)	95
Door opening height:	
11 foot 6 inch exterior (inches)	76
12 foot 6 inch exterior (inches)	88
Bed height (inches)	52

**Cubic Foot Capacity\***

22'	1115	36'	1825
24'	1216	38' (11' 6" height)	1828
28'	1419	38' (12' 6" height)	2300
32'	1622		

\*Approximately cubic foot capacity, clear door opening, overall height.

Some of the abbreviations used in the description of postal vehicles:

- AMG = American Motor General
- IHC = International Harvester Corporation
- RHD = Right Hand Drive
- LHD = Left Hand Drive
- SW = Station Wagon
- CA = California
- COE = Cab Over Engine
- CBE = Cab Behind Engine
- SA = Single Axle
- SD = Single Drive
- TD = Tandem Drive

**274.42 Rectangular Wire Mesh Containers**

Rectangular wire mesh containers come in two widths to fit either three abreast or two abreast in the 5- to 7-ton trucks or trailers. Handle and secure in the same manner prescribed for BMC containers and tray carts.

**274.43 Combitainers**

Similar to cargo cages, these demountable units have recently come into frequent use. While not fully modular to the vehicles, they should be handled and secured in the same manner as the other containers.

**274.44 General Purpose Mail Container**

This fold-up cart has retractable doors. The two doors make this cart a full container, protecting the load and preventing mail from falling from the container in transit. When not in use, the doors slide under the top shelf and bottom deck and lock in place. Gravity locks hold shelves in the up position, protecting the user. The cart can be folded to save space or folded for nesting. These carts are constructed using square tubing and have a noncorrosive zinc-plated finish. Dimensions are 67" high x 42" long x 29" wide.

**274.45 Post-Con Container**

The Post-Con is a four-wheel cart that is nestable and transports parcels, sacks, and trays. Dimensions are 67" high x 42" wide.

**274.5 Securing Tray Carts.**

For storage of straps when not in use and for securing tray carts, see the following exhibits:

- a. Secured Tray Cart (Exhibit 274.5a)
- b. Straps Not In Use (Exhibit 274.5b)

Exhibit 274.5a  
**Secured Tray Carts**

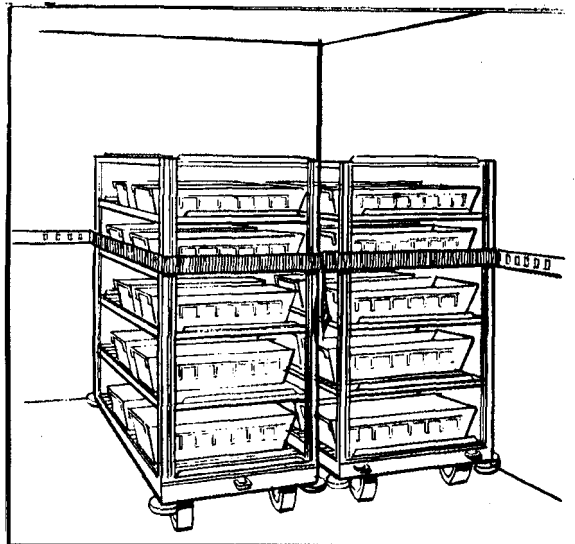
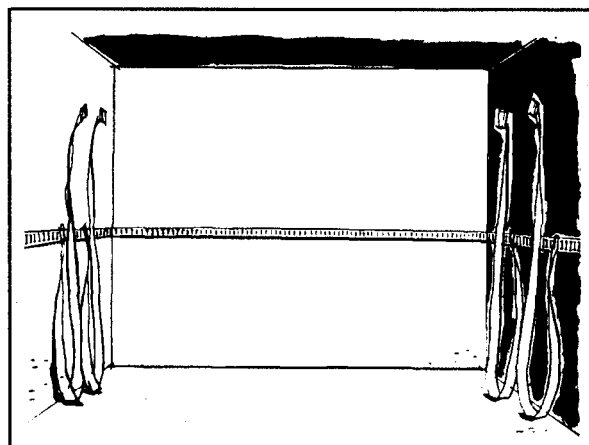

Exhibit 274.5b  
**Straps Not in Use**



**275 Leveling Devices**

Cost justification for installing leveling devices should include the following and be based on a 15-year amortization period.

- a. Adjustable Dock Ramp.
- b. Horizontal Vertical Lift Scissors Piston (see Exhibit 275b).
- c. Adjustable Truck Levelers.
- d. Permanent Dockboard (see Exhibit 275d).

Exhibit 275b

**Horizontal Vertical Lift (Scissors)**

Exhibit 275d

**Three Views of Permanent Dockboard**

276 **Loading Diagrams**

Suggested loading and control methods for the 5- to 7-ton trucks and the 22-, 35-, and 38-foot trailers are as follows:

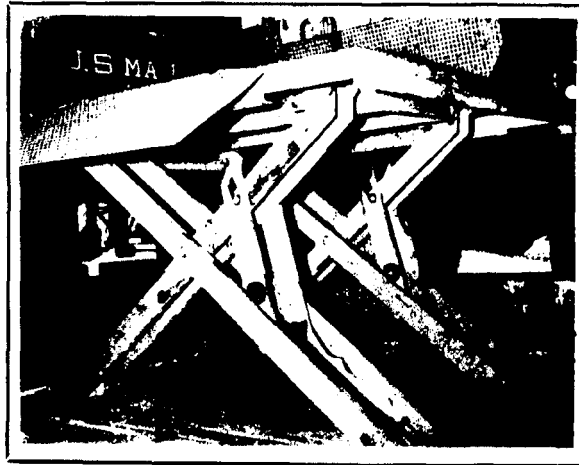
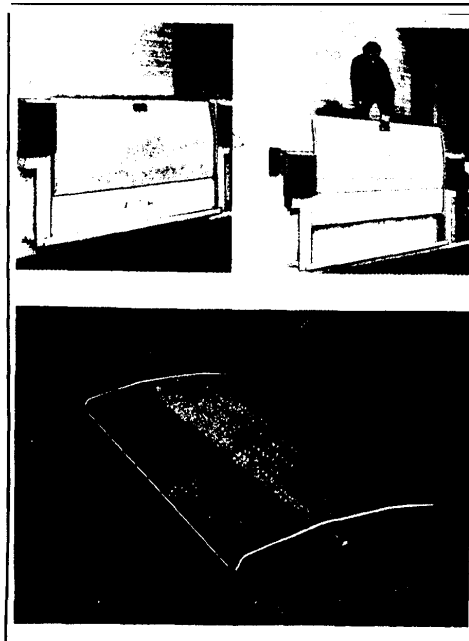
- a. Hamper Loading (see Exhibit 276a).
- b. Tray Cart Loading (see Exhibit 276b).
- c. Postal Pak Loading On Postal Vehicles (see Exhibit 276c).
- d. Roller Conveyors (laid flat on trailer bed with walkway between for easier loading of pallets and cartons) (see Exhibit 276d).
- e. Airlift "Igloo" (on roller tracks within trailer body; secured in place by wedge between rollers) (see Exhibit 276e).
- f. Shoring Bar Sockets and Beam (see Exhibit 276f).
- g. Horizontal A- or E-Track (retaining rails for logistic straps or shoring bars) (see Exhibit 276g).
- h. Heavy-duty Vertical E-Track (see Exhibit 276h).
- i. Installing Shoring Bar In Horizontal A- or E-Track (see Exhibit 276i).
- j. Installing Nylon Belting on A- or E-Track (see Exhibit 276j).
- k. Leather Boot (used to protect nylon belting from sharp edged containers) (see Exhibit 276k).
- l. Ratchet Action Buckle (see Exhibit 276l).
- m. Care of Ratchet Action Buckle (see Exhibit 276m).

Exhibit 276a  
**Hamper Loading**

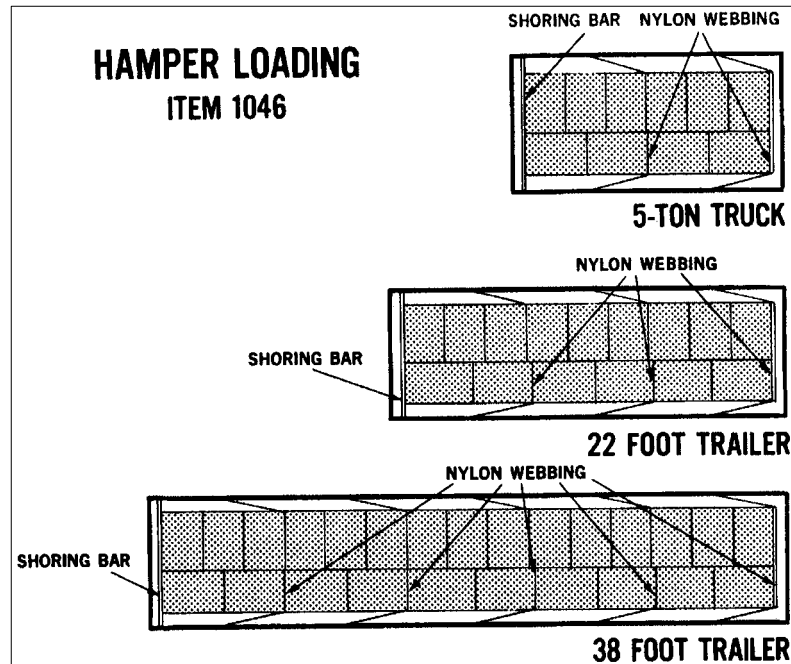
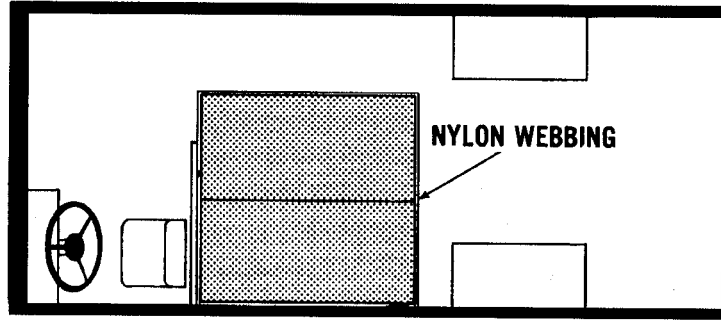

Exhibit 276b  
Tray Cart Loading

# TRAY CART LOADING

ITEM 1226b



2 TON TRUCK

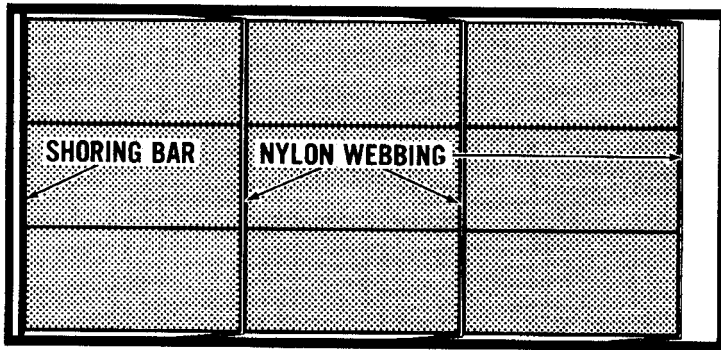

5 TON TRUCK

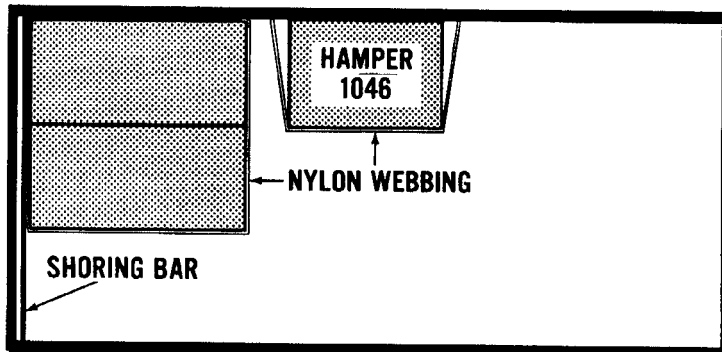

5 TON TRUCK (partial load)



Exhibit 276c  
Postal-Pak Loading on Postal Vehicles

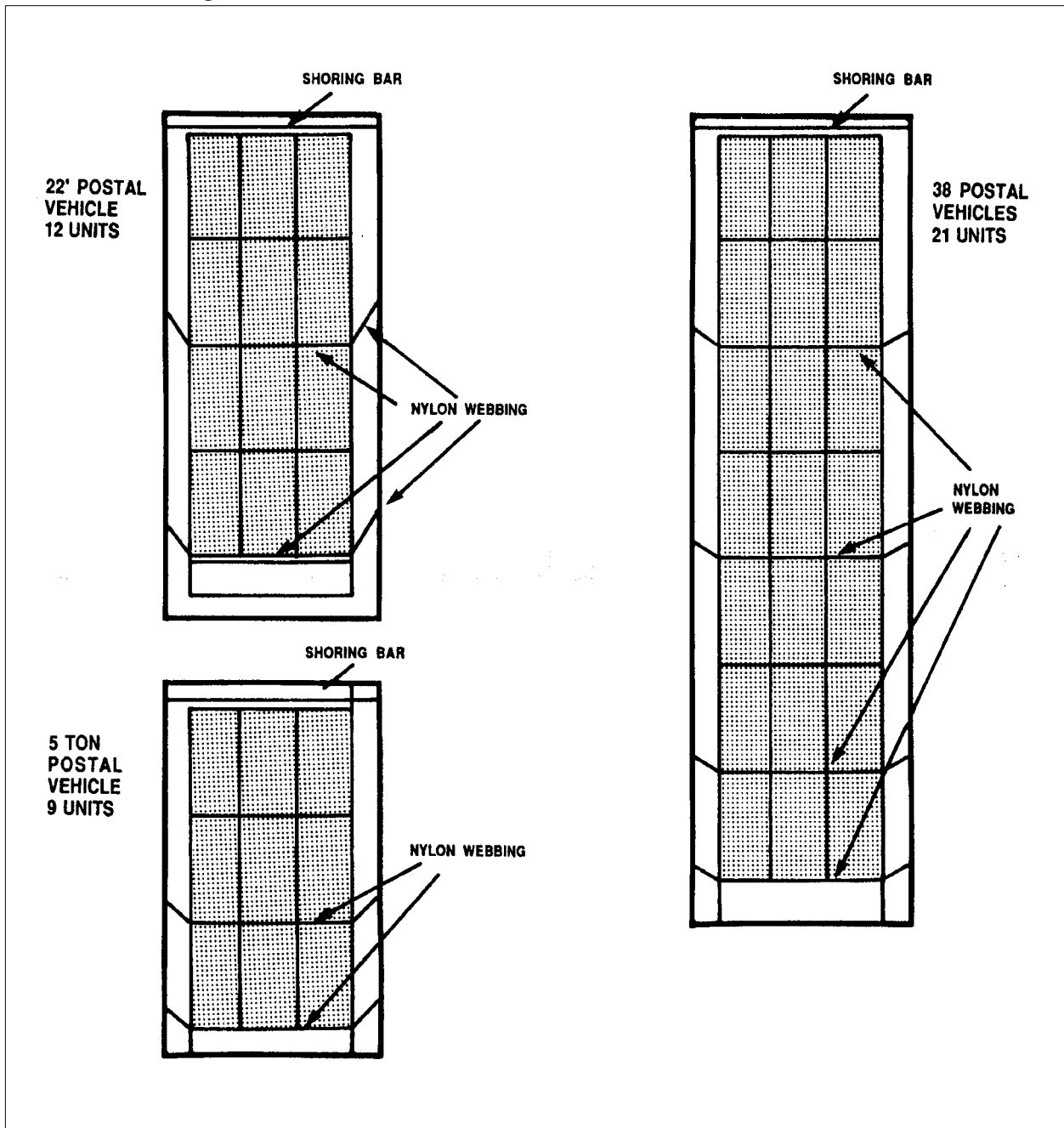

Exhibit 276d  
**Roller Conveyers**

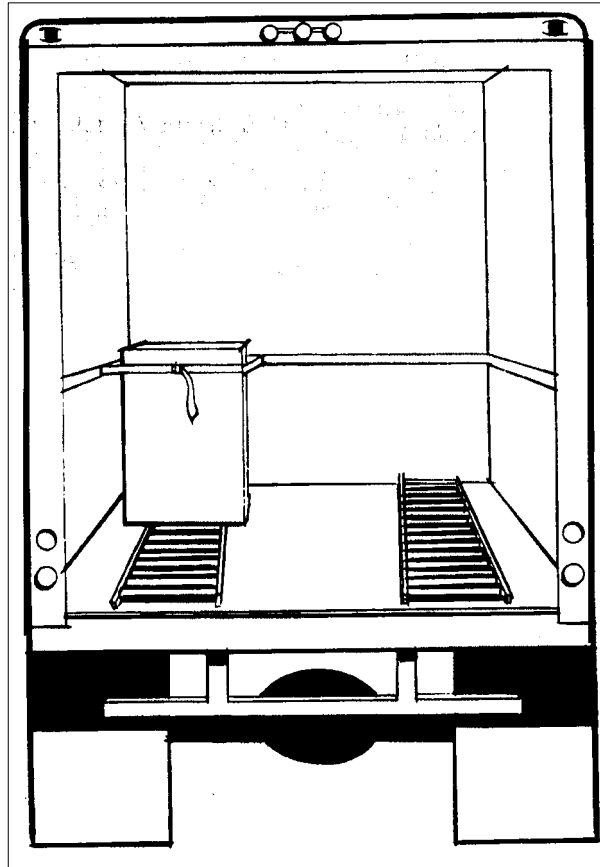

Exhibit 276e  
**Airlift "Igloo"**

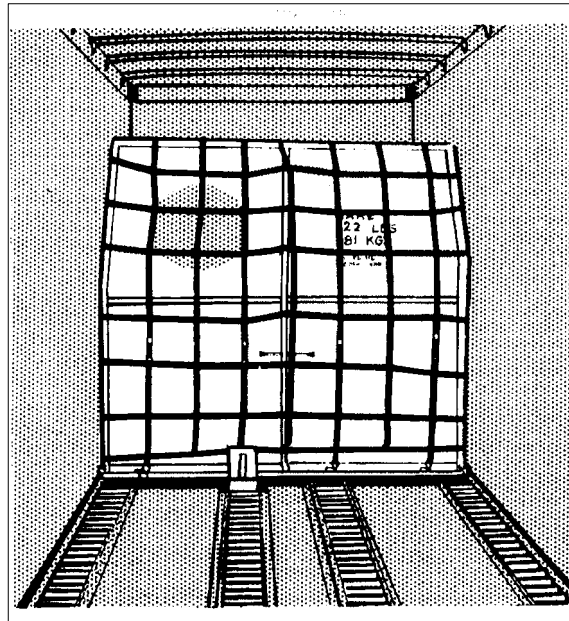

Exhibit 276f  
**Shoring Bar Sockets and Beam**

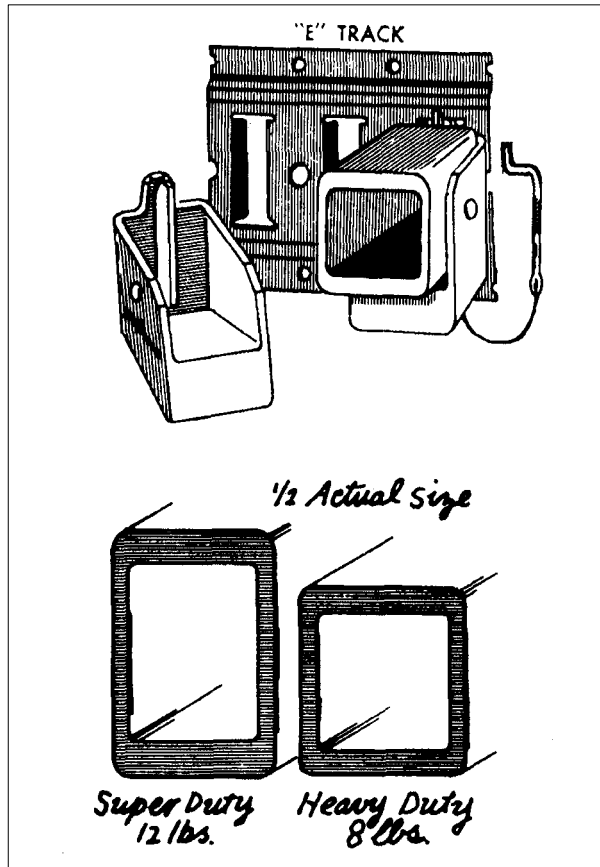

Exhibit 276g  
**Horizontal A- or E-Track**

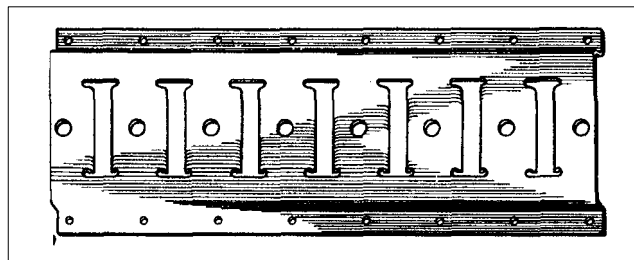

Exhibit 276h  
**Heavy Duty Vertical E-Track**

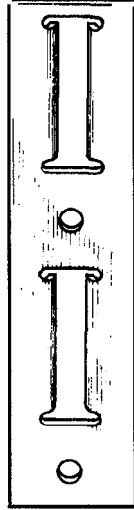

Exhibit 276i  
**Installing Shoring Bar in Horizontal A- or E-Track**

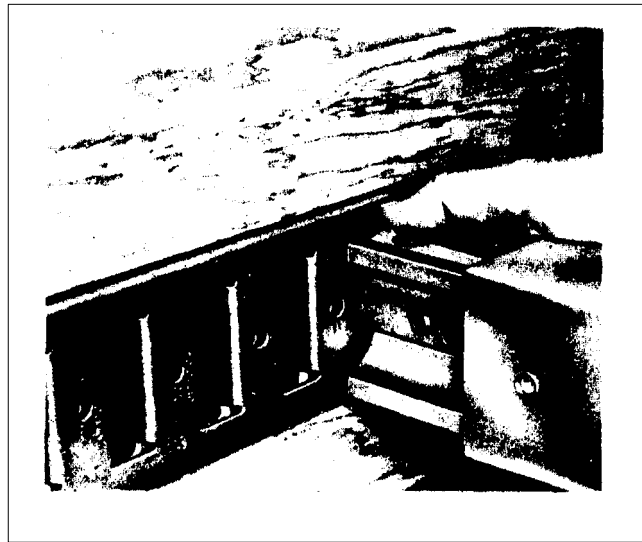

Exhibit 276j  
**Installing Nylon Belting on A- or E-Track**

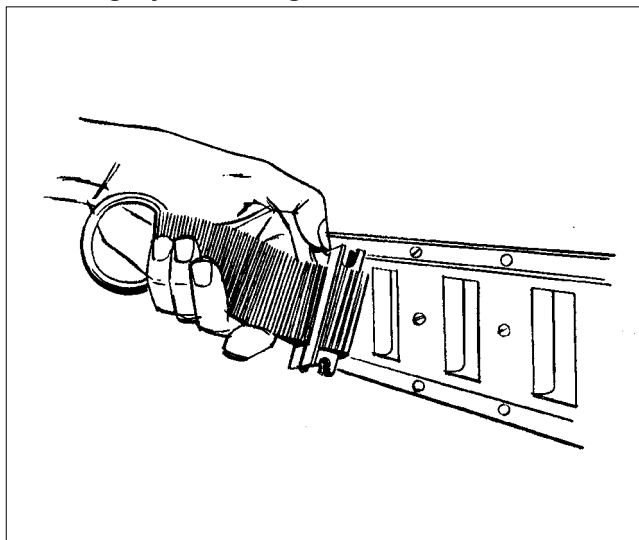

Exhibit 276k  
**Leather Boot**

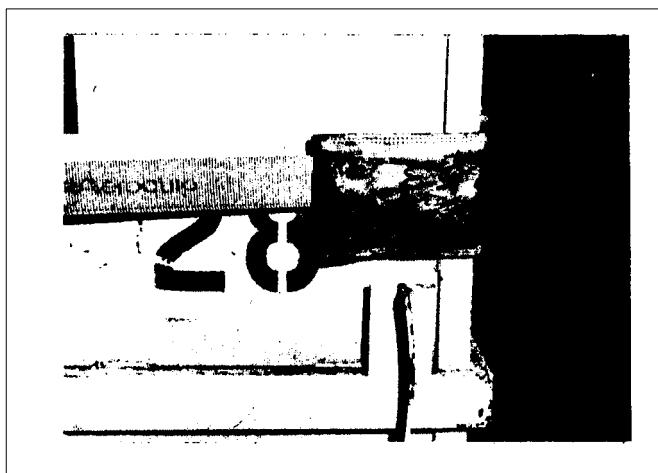

Exhibit 276I

**Ratchet Action Buckle****Securing The Load**

The assembly is now draped across the face of the load. DO NOT attempt to operate ratchet at this time.

Hold the buckle at about the same level as the attached end fittings AND pull slack webbing through the buckle (Figure 1) until the straps and buckle are SNUG against the load.

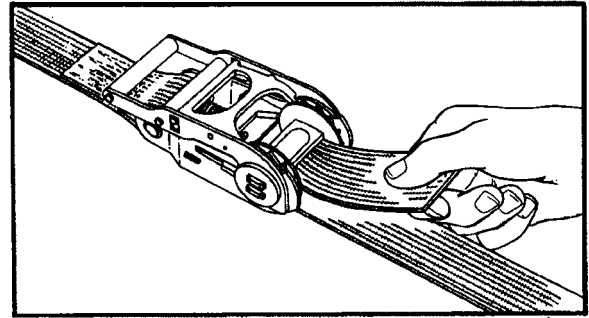

Figure 1

The ratchet mechanism can now be operated properly because there is NO EXCESS SLACK that could, if wound up on the reel, cause jamming.

Operate buckle handle back and forth to take up remaining slack and to set tension as shown in Figure 2. Continue ratcheting until enough tension is applied to hold the load secure.

DO NOT use tools to operate the buckle handle.

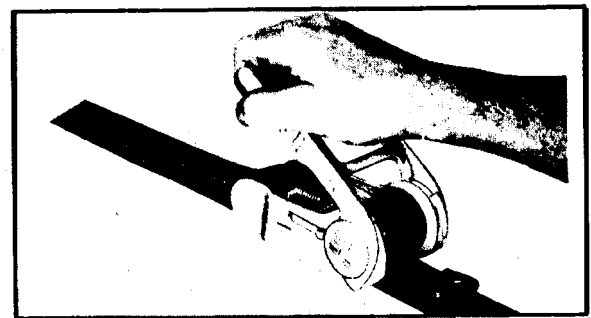

Figure 2

**Releasing the Buckle**

To release the buckle, depress the release bar with the thumb (Figure 3) and swing handle as far as it will go from the buckle body (Figure 4).

With the handle held in this position, webbing spool will turn freely and unwind the webbing.

NO TOOLS are necessary.

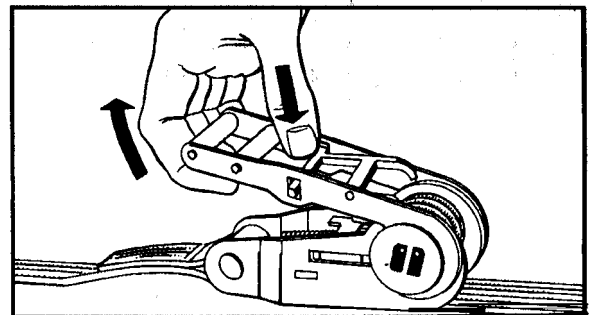

Figure 3

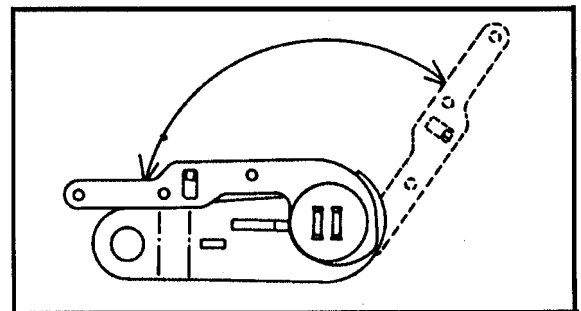

Figure 4

Exhibit 276m

**Care of Ratchet Action Buckle**



Avoid spooling unneeded webbing on the buckle; this will cause the buckle to jam. If webbing does become jammed remove carefully. Force will make the problem worse and could damage the assembly.

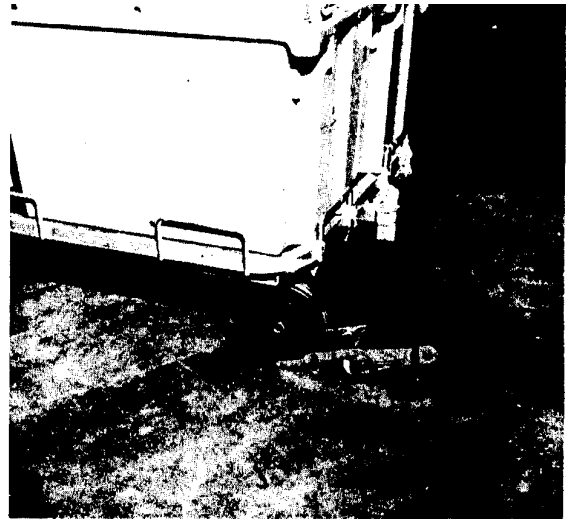

Buckles can become permanently damaged if run over by heavy carts, dollies, or trucks. This is especially true if the buckle is left in the open position. Keep buckles closed and off the floor when not in use.



Knots tied in the webbing to gain shorter working lengths will be impossible to untie after tensioning. Adjust to required length by pulling extra webbing through the buckle until "hand tight." After ratcheting, drape excess webbing over the assembly.



"Cheater bars," used on buckles to give added tension, can deform or break the buckle. The hand ratcheting mechanism was designed to give sufficient tension to secure the load without additional leverage.

This page intentionally left blank



# 3 Fleet Maintenance and Control

## 31 Purpose, Objective, and Guidelines

---

### 311 Purpose

The purpose of the maintenance program is to maintain vehicles in a mechanically reliable, safe, clean, and neat condition available for maximum mail transportation use. Accomplish this purpose in compliance with established requirements in the most economical manner possible.

### 312 Objective

The objective of the vehicle maintenance program places primary emphasis on preventing (rather than correcting) major repairs. Scheduled maintenance is prescribed to implement this objective by providing periodic, systematic examination and service of postal-owned vehicles. To accomplish this objective, complete all required scheduled maintenance actions as prescribed in Handbook M-4, *Vehicle Maintenance Program Guidelines*, manufacturers' manuals, and Fleet Management Bulletins, within the established cycle date and before returning the vehicle to service.

### 313 General Guidelines

To accomplish the vehicle maintenance program purpose and objective, adhere to the following guidelines:

- a. Perform maintenance, to the extent possible, on a scheduled basis to provide the least interruption of regular mail transportation service.
- b. Provide training to vehicle personnel to ensure efficient and professional performance of all duties assigned.
- c. Have supervisors maintain all necessary control procedures to ensure that maintenance work is performed in a safe manner and that related costs are not excessive.
- d. Review quality and costs of outside contractual maintenance and take follow-up corrective action when warranted.
- e. Assign the most reliable vehicles to vehicle post offices (VPOs) and to outlying stations and branches to reduce overall fleet repair costs.

- f. Direct supply and stockroom procedures to facilitate efficient shop operations. Follow prescribed procurement practices to avoid costly out-of-stock parts and materials.
- g. Establish and maintain registers for recording and processing work orders and other documents. Provide supervisory attention to ensure compliance.
- h. Place in storage (pending sale) serviceable, unserviceable, or surplus vehicles that have been replaced or authorized for disposal.
- i. Initiate quality control in maintenance procedures to maximize vehicle performance and ensure the highest level of vehicle appearance and safety.

## 32 Organizational Structure of Vehicle Maintenance Facilities

---

### 321 **Functional Areas**

Vehicle Maintenance Facilities (VMFs) will ordinarily have three functional sections: administrative/supply, vehicle maintenance, and vehicle operations. At many facilities, the responsibilities of various sections will be combined.

### 322 **Responsibility**

#### 322.1 **Region**

Regions are responsible for establishing and approving organizational functions and positions. Establish the organizational structure based on workload requirements.

#### 322.2 **Field Division General Manager**

Establish VMF complements in accordance with demonstrated need, and follow the policy guidelines of the region. Base staffing, in part, on planned repairs to components and subcomponents. Economics will help determine whether reconditioning and complete overhaul should be performed commercially or at the VMF. Positions which require approval by the field division manager, which may not be delegated to the Management Sectional Center (MSC), include:

- a. Supervisor, Vehicle Maintenance.
- b. Supervisor, Body Shop.
- c. Supervisor, Auxiliary Garage.
- d. Supervisor, Vehicle Dispatching (A).
- e. Supervisor, Accident and Claims Investigator.
- f. Accident and Claims Investigator.

**322.3 MSC Manager**

The MSC manager establishes the following positions if delegated authority is given by the division manager:

- a. Tire Repairman.
- b. Garageman.
- c. Tool and Parts Clerk.
- d. General Clerk, VMF.
- e. Motor Vehicle Operator.
- f. Office Clerk, Vehicle Operations.
- g. Clerk, Vehicle Dispatching.

**322.4 Headquarters**

All other nonbargaining positions require approval by the Office of Organizational Requirements, Headquarters.

**322.5 Fleet Manager**

The fleet manager is responsible for providing copies of all necessary maintenance manuals and publications to VPOs assigned to the VMF for maintenance support. This includes technical publications, Fleet Management Bulletins, and Vehicle Modification Orders. The fleet manager is also responsible for submitting requests for changes in quantities of Fleet Management Bulletins and Vehicle Modification Orders to:

OFFICE OF FLEET MANAGEMENT  
US POSTAL SERVICE  
475 L'ENFANT PLAZA SW  
WASHINGTON DC 20260-7240

**322.6 Shop Supervisor**

The designated shop supervisor plans, directs, and has overall responsibility for the maintenance, servicing, and repair of postal-owned vehicles.

**323 Acquiring or Expanding VMFs****323.1 General**

Facilities may be acquired by leasing or purchasing an existing building or by constructing a new building. In some instances, existing leased or owned buildings may be enlarged by agreement with the lessor or by expending capital funds. In all instances (lease, purchase, enlargement, or construction), acquisition or expansion is governed by the provisions of Publication 191, *Capital Investment Implementation Instructions*.

### 323.2 **Considerations for Expansion**

When additional capacity is required in metropolitan areas, give consideration to acquiring an auxiliary facility when one or more of the following conditions exist:

- a. Vehicles operate from stations or branches some distance from the nearest VMF or auxiliary VMF, and as a result the maintenance program suffers.
- b. Excessive losses are created by deadhead travel.
- c. Excessive costs are incurred from shuttling vehicles to and from the VMF.
- d. Satisfactory contract maintenance is not available.

### 323.3 **Planning Expansions**

Postal managers should use Form 4551, *Projected Fleet Requirements*, which assigns responsibility and provides guidelines for planning and developing VMFs. Form 4551 outlines a formula for arriving at estimates of space requirements based on the size of the local vehicle fleet. Designated personnel at the division or region will determine actual space requirements.

### 323.4 **Establishing VMFs at Vehicle Post Offices**

#### 323.41 **MSC Manager/Postmaster Responsibilities**

At a VPO where the number of vehicles warrant and satisfactory contract maintenance is not available, the postmaster must determine whether establishing a VMF or an auxiliary or mini VMF is in the best interest of the Postal Service. The postmaster must define the alternatives (for example, to continue as is, lease or purchase a building, construct a building, or procure service from an existing VMF in another city), make an estimate of the annual operating costs of each alternative, and write a statement enumerating the advantages of the alternative selected.

#### 323.42 **Final Approval**

For establishment of an auxiliary or mini VMF, the MSC manager/postmaster must submit the above information to the field division general manger for final approval.

## 33 **Vehicle Post Offices Vehicles**

---

### 331 **General**

Each postal unit having Postal Service vehicles assigned will be designated as a VPO and will be assigned to an area VMF for maintenance and technical guidance. The applicable fleet manager Fleet Management will establish the vehicle maintenance program at VPOs. To ensure that vehicles at VPOs are properly maintained, the fleet, manager or designee must visit each VPO at least once per year. Areas for review include condition of fleet,

vehicle records, and maintenance procedures. The fleet manager or designee will initiate necessary corrective action.

### 332 **VPO Vehicle Maintenance Schedules**

#### 332.1 **Responsibility**

The fleet manager is responsible for preparing vehicle maintenance schedules for the vehicles assigned to each VPO, indicating with an asterisk those services which will be performed by the VMF. The fleet manager will forward one copy to the VPO and retain one copy for use at the VMF.

#### 332.2 **Repairs Over \$250**

When the estimated contract repair cost of a vehicle assigned to a VPO exceeds \$250, the responsible manager must contact the area fleet manager for approval to exceed the \$250 limit and obtain technical advice on the best method of repair. After repair is completed, the VPO should note fleet manager approval and date of approval on all copies of Form 4541, *Order-Invoice for Vehicle Repair (Commercial Work Order)*, or vendor's invoice.

## 34 **Scheduled and Unscheduled Maintenance**

---

### 341 **Scheduled Maintenance**

#### 341.1 **General Guidelines**

Scheduled maintenance programs and guidelines are furnished for all vehicles. The interpretation and application of these programs, developed and based on local conditions, national historical experience, manufacturer's recommendations, and technical research, is the responsibility of all field managers. Provide specific preventive maintenance procedures for each type of mail-carrying vehicle as evaluations on each are completed. Pending publication of individual maintenance programs, use the manufacturer's specifications and the general maintenance procedures in Handbook M-4, *Vehicle Maintenance Program Guidelines*.

#### 341.2 **The Maintenance Year**

The maintenance year commences on the first week of the fiscal year. A systematic schedule for the performance of scheduled maintenance is of paramount importance. If a vehicle is in the shop for unscheduled repair maintenance within two weeks prior to the scheduled maintenance date, perform the scheduled maintenance in conjunction with the repair action to preclude unnecessary shuttle and downtime. Scheduled services that are more than two weeks in arrears during any maintenance period are considered excessive and must be corrected.

**341.3 Maintenance Periods****341.31 Less Than 500 Miles**

Provide service for 1/4-ton, 1/2-ton and 1-ton vehicles accumulating less than 500 miles per A/P on a twice-yearly basis (twenty-six-week cycle).

**341.32 More Than 500 Miles**

Provide service for 1/4-ton, 1/2-ton, and 1-ton vehicles accumulating more than 500 miles per A/P on a seventeen-week basis.

**341.33 Less Than 2,000 Miles**

Schedule two 1/2-ton and larger vehicles on a thirteen-week basis when mileage is less than 2,000 miles per A/P.

**341.34 More Than 2,000 Miles**

Schedule two 1/2-ton and larger vehicles on a six- to seven-week basis when mileage exceeds 2,000 miles per A/P.

**341.35 Cycle Groups****341.351 General**

Divide vehicles assigned to groups according to their maintenance period to equalize the maintenance workload. Phase new vehicles into the cycle group. Schedule examinations so that each new vehicle takes the place of an old one in the cycle.

**341.352 Six- to Seven-Week Cycle**

Place spotter tractors on a six- to seven-week maintenance cycle.

**341.353 Other Weekly Cycles**

The maintenance periods for scheduling preventive maintenance will be seventeen to twenty-six weeks for 1/4-ton, 1/2-ton, and 1-ton vehicles and approximately thirteen weeks for heavier vehicles.

**341.4 Items Performed in Conjunction With Scheduled Maintenance****341.41 Polishing**

Schedule the polishing of vehicles to cut road film on an as-needed basis, but not less than once each year.

**341.42 Painting and Body Repair**

VMFs equipped to perform paint and body work should normally schedule vehicles requiring repainting to coincide with scheduled service. Schedule paint and body damage caused by accidents for immediate repair. VPO vehicles should be painted by contract when the distance involved does not normally permit services to be furnished by the VMF. All postal-owned vehicles must be repainted on an as-needed basis, as determined by the fleet manager or responsible VPO Postmaster.

**341.43 Lubrication**

Use lubrication charts supplied by vehicle manufacturers to perform scheduled lubrication maintenance.

**341.44 Tire Inflation**

Inflate tires during scheduled maintenance. Post a copy of Poster 49, *Tire Pressure Chart*, in all areas where tires are inflated.

**341.45 Wear and Tear Conditions**

During scheduled services, accomplish any repairs caused by rust or corrosion conditions, ordinary contact of bumper while parking vehicles which does not inflict a dent or distortion in body, or any other such contacts that over a period of time cause an accumulation of small scratches of the normal "wear and tear" type.

**342 Unscheduled Maintenance****342.1 Road Calls**

Upon receipt of a road call, prepare Form 4543, *Vehicle Maintenance Work Order*. Include the vehicle number, assigned location, comprehensive description of the problem reported, and location of the vehicle. When the service call is complete, the mechanic will initial the Form 4543 to show the driver's initial, action taken, and the time required. If additional work is required when the vehicle is returned to the dispatch point, advise the dispatch point supervisor to hold the vehicle for repairs. Do not use Account Code 28, Shuttle, for a road call. Carefully review all work orders so that the responsibility for poor driving habits or carelessness may be corrected.

**342.2 Accident Repairs**

A motor vehicle accident is defined as an occurrence involving a vehicle that results in death, injury, or property damage. Consider occurrences due to errors in judgment, driver technique, or maintenance as accidents. Blame or preventability have no bearing in determining whether an accident has occurred. The amount of damage or cost of repair is likewise not a factor. Bending or crushing a fender, panel, or bumper is not a "wear and tear" incident and must be handled as an accident. Charge all work necessary as the result of an accident (whether reported or not) on Form 4543, *Vehicle Maintenance Work Order*, by individual vehicle number. When accident damage is sufficient to warrant immediate repairs, charge only work pertaining to a single accident on each work order. Charge time spent by VMF personnel in towing or shuttling the vehicle to a garage to the appropriate accident Account Code 25 or 42 on the individual accident work order. Code work orders covering accident charges to be borne by the Postal Service to Account Code 25, Accident Repairs. Code charges for which the Postal Service is to be reimbursed to Account Code 42, Maintenance and Repairs Chargeable to Others (except warranty.)

**342.3 Component Repairs**

When components such as alternators, starters, engines, transmissions, and so forth, are repaired at the VMF and placed in stock, they will be commingled with original equipment manufacturer (OEM) parts under the identical part number. Enter these parts into the Vehicle Management Accounting System (VMAS) inventory at zero cost. Tag all parts with Form 4538, *No Value Item* (tag). Make every effort to issue the tagged parts at the VMAS indicated average price. Charge the cost of labor and materials to Account Code 26, *Unscheduled Repairs*. This is not intended to encourage rebuilding components in lieu of exchange, unless it can be economically justified.

**342.4 Testing New Products**

Submit new products considered for testing at the local level through channels, according to the procedures in Fleet Management Bulletin 10-87, which were established for local vehicle modifications, to the Office of Fleet Management, who may authorize local testing.

**343 Form 4513, Scheduled/Unscheduled Maintenance Record, and Form 4513-A, Scheduled/Unscheduled Shop Maintenance****343.1 Purpose**

VMF Managers use Form 4513, *Scheduled/Unscheduled Maintenance Record* (and Form 4513-A, *Scheduled/Unscheduled Shop Maintenance*), as a tool to plan work assignments. Also use these forms to record all service performed, both at the VMF and other locations. The reverse side of Form 4513-A reflects the number of employees scheduled and reporting. Form 4513-A provides management with a ready source of information relative to the shop workload and detailed reasons for delays in completing repairs. The applicable VMF supervisor will comprehensively review the Form 4513 on a daily basis, rectify any inconsistencies, especially unnecessary delays in completing repairs, and sign in the appropriate space.

**343.2 Fleet Manager Review**

The fleet manager will review the Form 4513 daily, noting any irregularities, taking necessary corrective action, and signing in the appropriate space.

**343.3 Handling Delays**

If all local efforts to obtain repair parts or warranty service have been exhausted, contact designated personnel at the division after five days for assistance in expediting repairs.

**343.4 Retention**

Retain completed forms at the VMF in accordance with the records retention schedule.



## 344 **Form 4543, Vehicle Maintenance Work Order**

### 344.1 **General**

Form 4543, *Vehicle Maintenance Work Order*, prepared for all scheduled and repair maintenance actions, requires a minimum of clerical effort and ensures a comprehensive record of work performed. It contains direct labor hours and material costs chargeable to a specific vehicle.

### 344.2 **Preparation**

Prenumber all Forms 4543 with a four-digit numeric or alphanumeric number prior to recording any parts or labor. Auxiliary VMFs will use an alpha prefix to identify each location. Maintain a log at all locations, identifying each assigned number with a minimum of date, vehicle number, account code, and type of service. Close the log at the end of each A/P and retain for three A/Ps.

### 344.3 **Scheduled Maintenance**

Prepare Form 4543 for scheduled maintenance (a minimum of) three weeks in advance of the maintenance week. The administrative office is responsible for the initial preparation of Form 4543 which includes, but is not limited to, the vehicle number, type of service, and due date, and so forth.

### 344.4 **Unscheduled Maintenance**

Prepare Form 4543 for individual vehicles to record repairs resulting from road calls, tag repairs, accident repairs, and so forth.

### 344.5 **General Use of Form 4543**

While examining the vehicle, the designated employee(s) will determine the nature and extent of work to be performed by referring to the vehicle jacket. Mechanics and other service personnel are encouraged to identify vehicle defects. Designated employees must use pertinent manufacturers' flat rate time schedules as guides in developing and entering estimated repair time (ERT) in the absence of individual vehicle maintenance programs. The individual who signs Form 4543 will ensure that all pertinent information is recorded.

## 35 **Vehicle Modifications and Repairs**

---

### 351 **Types of Modifications and Repairs**

#### 351.1 **Minor Changes and Repair Techniques**

Minor changes are defined as changes to certain components which may improve the component and render the vehicle more functional without altering the appearance or structural design of the vehicle. Such changes or the required repair techniques, including monetary costs and benefits, must be reported to designated personnel at the region or division for further

consideration. Report defects in vehicles in the VMAS system. No changes whatever may be made in the construction of a vehicle. (Refer to section 745.2, *Postal Operations Manual*.)

### 351.2 **Modifications to Air Pollution Control Devices**

The U.S. Postal Service is cooperating with the EPA, Department of Transportation, and state agencies to reduce vehicle pollution. Check exhaust emissions performance at each scheduled maintenance service and bring within specifications. Vehicle pollution control devices must be properly maintained. Make no modifications of the system or its components without direction from the Office of Fleet Management.

**Note:** Contractors are prohibited by law from making changes to pollution control equipment, unless certified by EPA.

### 351.3 **Vehicle Modification Orders**

Accomplish modifications as authorized by VMOs within the time specified in the VMO. Submit accurate and timely VMAS reports if required by the VMO. The fleet manager must keep a record of performance for each VMO and ascertain whether a report is required. Also include the vehicle number and date completed with the information to be recorded. Retain this record as long as affected vehicles are in the Postal Service fleet.

### 351.4 **Borrowed Vehicle Repairs**

Prepare individual work orders to record labor and parts used in the maintenance and repair of borrowed vehicles. The work orders should show Account Code 91, Maintenance and Repair of Post Office Equipment. Indicate inspection time, if necessary, and times to pick up and return (shuttle) the vehicle(s) on work order(s) as Account Code 91 also.

## 352 **Recording Modification Parts and Labor**

### 352.1 **Parts and Materials**

Obtain parts or materials by presenting the work order to the stockroom. The stockroom employee will enter the quantity, current part number, and description in the parts column. When all parts are assembled and correctly entered on the work order, the assigned employee will verify receipt of the parts by initialing in the appropriate column.

### 352.2 **Labor**

The vehicle analyst, lead mechanic, body and fender repairmen, painter mechanic, junior mechanic, and garagemen must record all work time on a work order. To the extent possible, use a timeclock to record beginning and ending times. When a timeclock is not available, employees must manually record on the work order the amount of time expended on each line item, their employee number, and initials if the line item is completed. Write-in times are only acceptable for work performed at locations remote from the VMF and must be initialed by the tour supervisor.

## 36 Safety Standards and Practices

---

### 361 General

#### 361.1 Standards

Enforce approved shop and office safety practices. Follow local, state, and Occupational Safety and Health Administration (OSHA) regulations in addition to the requirements contained within this text.

#### 361.2 Ventilation

Do not run engines for prolonged periods in the repair area without adequate ventilation. Do not run engines in standby areas or inside buildings.

#### 361.3 Housekeeping

Immediately clean slippery areas caused by oil and grease spills. Contact the local manager, plant maintenance, for guidance and available cleaning solutions. Sawdust is not acceptable as a floor sweep to clean oil or grease spots.

#### 361.4 Oil Additives

Use of additives not recommended by OEM is not permitted.

#### 361.5 Face Masks and Respirators

Employees performing brake/clutch repairs (asbestos exposure) must wear approved face masks and respirators.

### 362 Lifts and Hoists

Before working on vehicles raised on hydraulic lifts not equipped with automatic safety devices, check to be sure that suspended vehicles are supported by jack stands or other approved means. Using jacks or chain hoists as the sole means of supporting a vehicle is prohibited. Employees may not perform work on raised vehicles unless the mechanical stopping device is activated or jack stands or other approved devices for supporting the lift are in place. All new hydraulic lifts must be equipped with an automatic mechanical stopping device to hold the lift at multiextended positions. Lifts that are not currently equipped with this stopping capability must have jack stands or other approved devices placed under the lift post frame at all levels of use. Do not leave vehicles on the lift or hoist in a raised position after the repair work is completed. When the repair work is incomplete, do not leave vehicles on lifts or hoists overnight without being lowered onto approved jack stands or other approved supporting devices. The fleet manager or designee will periodically check mechanical stopping devices, jack stands, and other approved supporting devices to ensure enforcement of safe work practices.

**363 Welding**

Use of approved protective equipment is mandatory when welding, using grinders, or working in the battery room. Do not perform welding in shop areas within 50 feet of flammable storage areas. Personnel engaged in welding and cutting operations must wear approved protective clothing and goggles or helmets with filter lenses. Operators must also shield and ventilate welding operations to protect other employees from arc flash and welding fumes. Welding on gasoline tanks, cadmium-plated assemblies, or panels is prohibited. Galvanized panels may be welded only if proper protective equipment is available and used. Install, maintain, and operate electric arc welding apparatus in accordance with the requirements of the National Electric Code and the American Standard Safety in Electric and Gas Welding Operations (ASA Z 49.1). Locate fire extinguishers adjacent to areas where welding or cutting is performed and maintain a fire watch during the operation and for 30 minutes thereafter. All personnel using welding equipment must be trained in proper welding procedures.

**364 Brakes**

Because asbestos dust is a health hazard, proceed as follows when replacing brakes and clutches:

- a. Refer to Management Instruction EL 830-88-9, *Asbestos Surveillance and Control in Vehicle Maintenance Operations*, for detailed control and maintenance procedures.
- b. Wear a dust mask approved for asbestos exposure.
- c. Use a vacuum cleaner or an approved wet system specifically designed to remove dust and asbestos from brake shoes, drums, and clutches. Do not blow the dust away with an air hose. Keep the brake shoe dust out of the air. Do not use regular or industrial vacuum cleaners. Use only vacuums equipped with high efficiency (HEPA) filter systems.
- d. Use extreme caution at all times to properly control brake shoe dust. Do not tap the shoes to dislodge the dust. Use an approved vacuum or wet system. Use a puller to remove the drums.
- e. Do not grind brake linings for use on Postal Service vehicles. The Postal Service will follow the practice of mating cam ground standard lining to all brake drums.
- f. Turn brake drums only to the extent necessary to remove the outer lip caused by friction material wearing away the metal and the amount necessary to correct an out-of-round condition.
- g. Store used brake shoes, dust gathered rags, and other materials containing asbestos fibers in properly marked, sealed containers. Wear proper face mask during handling. For disposal, see 366.21.

**365 Tires**

All multi-piece rim (split rim) tires must be inflated in an approved tire safety cage, pursuant to OSHA 1910.177. It is also suggested that all other rims and

tires be inflated within the safety cage. All personnel mounting, dismounting, and inflating tires must receive training from the Postal Employee Development Center (PEDC) in proper tire servicing procedures and must wear safety goggles while engaged in this activity. Current charts and rim manuals containing instructions for the type of rims being serviced must be available in the service area. The tire safety cage must be inspected prior to each use and after any explosive separation of wheel components. Immediately remove from service any device with defects such as cracks at the welds, cracked or broken components, bent or sprung components caused by mishandling or abuse, wheel separations, or pitting of components due to excessive corrosion. Do not return devices to service until they are inspected and repaired by the manufacturer or a registered professional engineer to meet strength requirements. If automatic inflators are used to seat beads, inflate the tire only to the minimum pressure necessary to force the tire bead onto the rim ledge. If a bead expander is used, remove it before the valve core is installed and as soon as the tire slips onto the bead seat. Accomplish final inflation with the tire and wheel secured in a safety cage. Use a clip-on chuck with sufficient hose to allow employees to stand clear of the tire's trajectory during inflation.

## 366 **Flammable Liquids and Hazardous Waste**

### 366.1 **Flammable Liquids**

#### 366.11 **General**

Do not use Class 1 flammable liquids (flashpoint below 100 degrees) such as gasoline, benzol, acetone, and so forth, for cleaning purposes. Make protective hand creams and solvent-resistant gloves available for use by personnel exposed to flammable cleaning solvents. Current OSHA Form 20 must be on file for all solvents used.

#### 366.12 **Storing Flammable Liquids**

Store flammable liquids in tanks, approved safety containers, or closed drums. Use tanks that conform to the requirements of UL Standard No. 58, Underground Tanks for Flammable Liquids, or UL Standard No. 142, Steel Above Ground Tanks for Flammable and Combustible Liquids, as applicable. Comply also with applicable requirements of the Interstate Commerce Commission (ICC) and state and local ordinances. Permits may be required. Mark the drums or containers appropriately and store them in nonsmoking areas. Maintain temporary storage of gasoline in approved safety containers.

#### 366.13 **Transporting Flammable Liquids**

A maximum of five gallons of gasoline may be transported on service vehicles for "out of gas" road calls. However, do not routinely leave gasoline in vehicles in anticipation of possible need. Carry the fuel in an approved safety container (NSN 7420-00-240-6958) and secure the container in a bracket to prevent undue movement or spillage while the service vehicle is in motion. Equip fuel dispensing pumps with automatic shut-off nozzles to

prevent splashing and overfilling. Remove the trigger locks on automatic shut-off nozzles.

366.14 **Disposing of Flammable Liquids**

Do not dispose of contaminated gasoline, flammable liquids, or engine oil in any sewer or other public drainage system—not even small amounts. Use local- and state-approved methods for disposing of these liquids. The VMF must keep a record of the latest approved methods on file.

366.2 **Hazardous Waste**

366.21 **Disposing of Hazardous Waste**

Dispose of all hazardous waste materials, such as used solutions from brake washers, asbestos dust from vacuum cleaners, and acids and caustic materials, in accordance with local and state ordinances. Never dump these types of materials into sewer systems or public drainage systems.

366.22 **Disposing of Flammable Waste**

Place oily rags and flammable waste in tightly covered metal containers. Dispose of such waste and rags daily. Use approved local and state disposal methods.

367 **Tools**

367.1 **Grinders**

Ensure that all bench grinders, abrasive wheels, and so forth, with safety glass protection plates are equipped in accordance with OSHA 1910.215. Do not operate unless all guards are clean and in proper position. Guard abrasive grinders with a standard hood that will protect both sides of the periphery. Provide a work/tool rest. Never let the gap between the abrasive wheel and the rest exceed 1/8 inch. Tongue guards should have a gap of not more than 1/4 inch. Replace stones any time the wearing patterns prevent adjusting work/tool rest to within 1/8 inch of stone. When replacing stones, exercise extreme caution by ensuring that the RPM speed of the grinder motor does not exceed the RPM limit of the stone. Check to ensure that stones are not cracked and that blotters have not been removed or damaged. Test wheel before use. Use of dressing tool is recommended to prolong wheel life and to ensure safety standards. Immediately replace frayed wire shields. Securely anchor all stationary grinders.

367.2 **Portable Electric Handtools and Equipment**

Ground all portable electric handtools and equipment. When available, use three wire ground type. If this ground type is not available or cannot be obtained, use double insulated or shockproof power handtools and equipment approved by Underwriters Laboratories (UL).

**368 Batteries**

When removing battery cases from vehicles for charging, thoroughly clean the case with an acid neutralized solution, such as baking soda. Check and clean cap vent holes. Do not change, remove, or manipulate battery terminal connections until the charging device is shut off. Charge batteries with all caps installed. Use battery carrying tongs and battery carts when handling batteries. Smoking or any type of open flame is prohibited in battery charging areas or during any battery servicing procedures. Adequately ventilate battery charging areas. Managers must ensure that employees who handle batteries follow the safety precautions outlined in Handbook EL-801, *Supervisor's Safety Handbook*.

**369 Safety Glass, Windshields, and Doors**

Use laminated safety glass for windshield replacement. All replacement glass and window attachments must be original equipment manufacturer or equivalent and must comply with the Motor Carrier Safety Regulations, Chapter 111, Title 49, U.S.C., and amendments. These regulations specifically preclude the use of any vision-reducing items such as screens on the side window adjacent to the operator.

## 37 Vehicle Fueling and Fuel Storage

---

**371 Purchasing Mobile Bulk Fuel Truck Tankers****371.1 Authorization and Policy**

Designated personnel at the division may authorize purchase of mobile bulk fuel truck/tankers when bulk facilities are not available, when economic analysis indicates that it is the most advantageous alternative, or when restrictive service hours or long service lines cause excessive overtime. Purchase these truck/tankers as one unit only. (Do not fabricate one in house.)

**371.2 Specifications and Requirements****371.21 Specifications**

Refer to research and development specifications for all truck/tanker purchases. Mobile bulk fuel truck/tankers must meet all local, state, and federal codes and specifications.

**371.22 Requirements****371.221 Fire Extinguishers**

Each truck/tanker must have the required fire extinguishers attached and easily accessible. (Refer to 243.)

**371.222 Wheel Chocks**

Each truck/tanker must have a minimum of two wheel chocks stored in the driver's side compartment. Place the chocks in the front and rear of the rear wheels on the driver's side of the tank at all times whenever the vehicle is parked and/or engaged in fuel transfer operations.

**371.223 No Smoking Signs**

Store sufficient size five-by-five-inch sandwich-type "Fueling — No Smoking" signs in the equipment compartment on the driver's side when not in use. Place these signs at each approach to fueling areas to warn smokers of the fueling operation per local ordinances. Stencil in four-inch red letters "**Flammable—No Smoking Within 50 Feet**" on the top, left, and right sides, and the rear end of the truck/tanker. Also stencil the warning on the front end of the truck/tanker using smaller letters to fit the restricted space.

**371.224 Designated Parking Areas**

Designated parking areas for truck/tankers must be at least 100 feet away from any building. Paint the area solid red. It is not necessary to post "NO Smoking" signs in the area as long as such warnings are painted on the body of the truck/tanker and are visible for at least 50 feet, as required.

**371.3 Certification and Inspection**

Truck/tankers must be certified by the local Fire Marshal before being placed in service. The fleet manager must maintain a record of certification. Inspect the truck/tankers as often as necessary, but not less than once per year.

**372 Fueling Bulk Mobile Truck/Tankers****372.1 From Supplier Depot**

Whenever fuel is purchased from a local supplier, take the truck/tanker to the supplier depot for refueling, except as noted in 372.2.

**372.2 From Storage Tanks**

When the supplier is so far from the VMF that sending the truck/tanker is not cost effective, refuel the truck/tanker from the in-ground bulk storage tanks. Ensure that the fuel truck and storage tanks are bonded and grounded in accordance with local ordinances. Use the bulk storage pumps and meters or an approved portable pump designed for this operation. If using a portable pump, the pump must meet all local, state, and federal codes and must have a meter connected between the bulk storage tank and the truck/tanker to maintain the integrity of the operation.

**373 Fueling Vehicles From Bulk Truck/Tankers****373.1 Fuel Type**

All postal vehicles certified for unleaded gasoline must be fueled with unleaded regular or gasohol. Use gasohol when the price per gallon is equal



to or less than the price of unleaded regular gasoline in compliance with Executive Order 1226.1.

373.2 **Smoking**

Smoking is not permitted while driving or operating the fuel truck/tanker. No smoking is permitted within 50 feet of the truck/tanker at any time. Place “No Smoking” signs at every approach to the fueling area in accordance with local ordinances. (See 371.223.)

373.3 **Positioning the Truck/Tankers**

During fueling operations, position the truck/tanker so that it is headed toward the nearest exit and away from buildings or other obstructions. When possible, conduct fueling operations on level ground. Ensure that the truck/tanker and vehicle being fueled are bonded and grounded before fueling operations begin. Stop fueling operations when there is an electrical storm or fire in the area. Keep all possible sources of vapor ignition away during the fueling operation.

373.4 **Wheel Chocking**

Chock the front and back of the rear wheels on the driver’s side when the truck/tanker is parked or engaged in fuel transfer operations. When possible, conduct fueling operations on level ground.

373.5 **Hoses and Nozzles**

Attend the discharge nozzle during fueling operations. Handles with automatic shut-off nozzles are not permitted. After the last vehicle is fueled, drain the discharge hose and carry the nozzle and discharge hose back to the truck/tanker. Do not drag these items on the ground.

373.6 **Recording Fuel Usage**

Complete and maintain Form 4574, *Daily Record of Gasoline, Diesel Fuel, and Motor Oil Issued*, in accordance with instructions. Record daily the beginning and ending pump readings and all issues for VMF city vehicles, VPO vehicles, and other agency vehicles. Automated fueling sites will substitute a daily computer listing of fuel dispenses and attach it to Form 4574 on which beginning and ending pump readings are recorded. Retain Form 4574 at the VMF.

373.7 **Reporting Fuel Spills**

Report fuel spills immediately to the supervisor and handle in accordance with local fire department instructions.

373.8 **Reporting Defects**

Immediately report any defects or malfunction of truck/tanker equipment to the supervisor. Take corrective action before placing the truck/tanker back in service.

**374 Bulk Fuel Storage**

Minimum storage capacity in truck/tankers is 12,000 gallons to enable purchase of transport tank loads. Installation must comply with Environmental Protection Agency regulations and local and state ordinances.

**375 Bulk Fuel and Oil****375.1 Purchasing Bulk Fuel and Oil****375.11 General**

Procedures for procuring bulk fuel for postal-owned vehicles are contained in the *Administrative Support Manual*. Maintain Form 4567, *Commercial Service Station Procurement Record*, for all fuel procurements without exception.

**375.12 Service Stations and the Defense Logistics Agency**

The Defense Logistics Agency (DLA) places contracts for bulk motor fuel and oil required by the USPS. When product shortages occur, DLA helps locate alternate supplies. Bulk fuel facilities should be installed where economically justified to ensure a continuing supply of vehicle fuel for the U.S. Postal Service. Where bulk fuel facilities are not available and cannot be economically justified, obtain motor fuel and lubricating oil from service stations offering the most economical service.

**375.13 Commercial Credit Cards****375.131 General**

Commercial credit cards are used at locations that do not have bulk fuel facilities. Major oil companies consolidate invoices sent to each servicing Postal Data Center.

**375.132 Application**

Postmasters, fleet managers, or officers-in-charge may obtain their own credit cards from authorized suppliers. Request the suppliers to imprint the cards to describe the vehicles supplied by that card as follows:

- a. *All USPS-owned vehicles except administrative (sedans, ambulances, carryalls, and so forth)*, Identify the post office, finance number, city, state, and ZIP + 4.
- b. *USPS administrative vehicles*. Identify the post office, finance number, city, state, ZIP + 4, and USPS vehicle number.

**375.133 Accountability**

The postmaster must maintain a control record file listing each credit card number, the expiration date, location of the receiving unit, and the name of the person responsible for the credit card. The unit using the credit card will also maintain a control record showing the date issued, card number, and expiration date. Before the existing credit card expires, issue the replacement. Recall and destroy the expired card. Note the action taken on the control record. When the vendor agrees, use Form 4567, *Commercial Service Station Procurement Record*, to reduce the number of charge tickets.

Solicit the cooperation of station operators in using the form, which has instructions on the back.

375.14 **GSA National Credit Cards**

GSA SF 149, *National Credit Card*, is used only in purchasing fuel for GSA vehicles. When oil company credit cards are used, USPS receives the discounts listed in the Defense Fuel Supply Center publication DFSCHG 4280.1, *Your Guide to Service Stations for Gasoline, Oil, and Lubrication*. Copies of this publication are available from the local fleet manager.

375.15 **Credit Other Than Credit Card**

Make every effort to use oil company credit cards. If this is not possible, arrange for a credit purchase by sending requests to the appropriate contracting office (for example, the Procurement and Materiel Management Service Center or Office).

375.16 **Cash or No Fee Money Order**

As a last resort, make payment within limits of local authority in cash or no fee money order. If purchases are for cash, drivers and other personnel must sign cash tickets instead of charge tickets.

375.2 **Processing Fuel Purchases**

375.21 **Postal-Owned Vehicles**

375.211 **Preparing Form 4567**

The post office supplies Form 4567, *Commercial Service Station Procurement Record*, to service stations. Instruct the vendor to prepare the forms in ink and include the following:

- a. The vendor name and the post office, station, or branch name.
- b. The quantity of fuel delivered to the nearest tenth of a gallon.
- c. The total price of the fuel shown on the pump.
- d. The quantity of engine oil (on the back of the form).
- e. The amount of transmission oil and other lubricants (code as Parts).
- f. Minor repairs and services (on the back of the form). If the service station operator does not agree to use the Form 4567, the responsible supervisor collects the individual charge tickets and completes and processes a Form 4567 as outlined above. The postal installation that purchased fuel must keep the "onion skin" portion of the oil company credit card invoice for recordkeeping and reconciling purposes. Attach these invoices to Form 4567, file them chronologically by vendor, and retain them for the current and prior fiscal year. Installations should file single oil company credit card invoices unsupported by Form 4567 chronologically by vendor and retain them for the current and prior fiscal year.

375.212 **Verifying Entries on Form 4567**

The post office employee making the purchase must verify the vendor's line entry, then date and initial the column headed "Driver Initial" on the same line

with the proper vehicle number. Inform the vendor that the driver's initials must be on the line before the charge ticket can be made.

#### 375.213 **Closing Out Form 4567**

Close out Form 4567 at the end of each seven-day period. Small operations may close out at the end of each A/P. The postmaster, fleet manager, or designated supervisory employee must:

- a. Take the credit card to the service station and have a charge ticket prepared.
- b. Check the accuracy and reasonableness of the quantities and cost of gasoline and oil. This is done by dividing the quantities shown on the form by the total cost, and comparing the unit cost thus determined to the posted cost.
- c. Total both sides of the Form 4567, subtract the discount, and have a charge ticket prepared for the total amount less any discount.
- d. Enter the charge ticket serial number on Form 4567.
- e. The postmaster, fleet manager, or OIC will sign below the following statement on the back of Form 4567:  

"I certify that the entries on both sides of this form have been reviewed, that the quantities and prices are reasonable, that the product and services were received for the Postal Service, and that the computations have been verified and are accurate."

#### 375.22 **Contract Vehicles**

##### 375.221 **Reporting Fuel Usage**

When a vehicle hire contract requires that the USPS furnish fuel and the vehicle is fueled at a retail station, these vehicles must be administratively assigned to a VMF for reporting fuel used.

##### 375.222 **Preparing Form 4567**

Maintain a separate Form 4567 at the using site for each contract headed "Vehicle Hire." Follow the same instructions for completing the form as shown for postal-owned vehicles on the form. Enter the contract number on the Form 4567, below the space for station or branch.

#### 375.3 **Fuel and Oil Inventory and Storage**

All gasoline or diesel storage tanks must be equipped with suitable filler cap locking devices and be inspected each A/P. Take gauge readings on inventories of motor fuel and oil in tanks at the end of each A/P. Enter readings (whole gallons of motor fuel and quarts of oil) into the microcomputer. Also, each A/P check underground tanks for water. Record the data checked on Form 4574, *Daily Record of Gasoline, Diesel Fuel, and Motor Oil Issued*. If one or more inches of water are found, request the local motor fuel contractor to pump the water out.

**375.4 Motor Fuel Pump Meters****375.41 Maintenance**

It is essential that motor fuel pump meters be accurate and kept within the accepted standards (plus or minus seven cubic inches on a five-gallon test). Perform tests quarterly and retain a memorandum record of these tests or meter corrections.

**375.42 Test Procedures**

The company furnishing motor fuels will generally make the dispensing meter tests on request without charge. If the service is not available without charge, procure a five-gallon gas container and use it for this purpose only. Whenever the meter seal is broken, it is mandatory that it be resealed. It is recommended that a supervisor be present to observe resealing.

**376 Minor Services****376.1 Selecting a Service Station Vendor**

The responsible fleet manager and postmaster must concur on the service station(s) to be used. Use the vendor most economically advantageous to the Postal Service. Keep in mind that selecting the most economical vendor cannot be based on the price per gallon of gasoline only. For example, the average fill for the 1/4-ton delivery vehicle is less than six gallons. Considering this, a two-minute carrier delay will cost more than the savings from a five-cent per gallon reduction in gasoline cost.

**376.2 Vendor Selection Factors****376.21 Shuttling Costs**

Be sure to include the driver's time and the cost per mile of operating the vehicle in the cost analysis.

**376.22 Hours of Operation**

The hours of the selected station(s) should be convenient for postal operations. The stations(s) should be able to perform minor repairs when the vehicle is not scheduled for use.

**376.23 Under the Hood Service**

The selected station(s) must be able to check the engine oil level, the transmission oil level, and the tire air pressure at prescribed intervals. Also, they must clean the glass areas at each fueling.

**376.24 Timeliness of Service**

Determine the projected delays for station(s) rendering services and ensure that they do not constitute an unreasonable timeframe.

**376.25 Emergency Service**

The service station personnel should be able to start engines, change tires, charge batteries, and make road calls.

## 38 Training Fuel Truck/Tanker Operators

---

**381 General**

Instruct all employees on procedures and equipment before they are assigned to operate fuel truck/tankers or any postal vehicle. Give local operating instructions and procedures to each vehicle maintenance employee. Post such instructions on vehicle maintenance bulletin boards and place a copy on a clipboard in the vehicle.

**382 Responsibility****382.1 Fleet Manager**

The fleet manager has responsibility for prescribing and arranging training and development for employees assigned to the VMF. The fleet manager should plan and budget training requirements to be commensurate with needs and programs in the area of responsibility. The fleet manager will identify individuals needing refresher training or specific course work by reviewing appropriate records and from shop observation. The fleet manager is responsible for providing listings of primary and alternate training candidates to Manager, Employment and Development and for ensuring that employees attend the classes to which they are assigned. If it is determined that both the primary and alternate nominees will be unable to attend a scheduled training course, the fleet manager must notify the PEDC as soon as possible, so the billet can be reassigned.

**382.2 Division**

Designated personnel at the division must coordinate the assignment of billets at the Technical Training Center, OT&D, Norman, OK, with the PEDC. Coordinate all training with the PEDC.

**382.3 Trainee**

Once an employee successfully completes a training course at the Technical Training Center, it is expected that the employee will use the new skills at the assigned office. Employees should share these new skills with co-workers whenever possible.

**383 Types of Training****383.1 Driver Instructor/Examiner**

The driver instructor/examiner or employee with driver training responsibilities must check each employee on operating procedures of the vehicle.

**383.2 Local Training Programs**

Design formal training programs locally to cover truck/tanker unique situations. Request the local Fire Marshal to give training on the use of fire extinguishers and to demonstrate how to extinguish gasoline and electrical fires.

**383.3 Safety Talks**

At least twice per year, or as needed, make operating instructions the topic of regularly scheduled safety talks.

**384 Recording Training**

Enter all training on employee training records.

**385 Training Aids and Technical Publications****385.1 Training Aids**

To further the value of technical training, it is essential that shop tools and equipment at VMFs be similar to the equipment used when training is given.

**385.2 Technical Publications**

Each VMF and VPO where contract maintenance service is provided must have a basic library of technical publications pertinent to the maintenance and repair of each type vehicle assigned to that facility. The publications must be available for use by mechanics, analysts, and others having need of such information. Supplement the manufacturer's shop, parts, and flat rate manuals with other technical material, such as Chilton's, Mitchell's Motor Manuals, and so forth, as needed.

This page intentionally left blank



# 4 Vehicle Management Accounting System

## 41 Overview

---

### 411 Definition

The Vehicle Management Accounting System (VMAS) is an integrated management control and reporting system designed to manage the Postal Service vehicle fleet.

### 412 Objective

The objective of VMAS is to provide a management tool for the effective and efficient operation and maintenance of the Postal Service vehicle fleet by providing timely and accurate cost accounting information on all aspects of fleet operations and maintenance.

### 413 Types of Data

#### 413.1 Management Data

Vehicle management data includes, but is not limited to types, quantities, locations, and ages of vehicles; maintenance costs; operations costs; and vehicle use.

#### 413.2 Accounting Data

Vehicle accounting data includes, but is not limited to parts, materials, and fuel inventory accounting; vehicle cost accounting; and vehicle asset accounting.

#### 413.3 Shared Data

The primary types of data that flow between the VMF and servicing Postal Data Center (PDC) are:

- a. Labor hours from Form 4543, *Vehicle Maintenance Work Order*.
- b. Purchase of inventory.
- c. Issuance of parts, materials, fuel, and oil.

- d. Physical inventory of parts, fuel, and oil.
- e. Contract and local purchases of parts, fuel, and services.
- f. Vehicle use.

#### 414 **General Guidelines**

Instructions and guidelines for preparing the system input and supplementing system output are documented in various publications. The following directives set forth procedures for operating the VMAS microcomputer. They also include descriptions of the various forms and documents that support VMAS.

- a. VMAS Microcomputer Operating Guide.
- b. Handbook F-41, *Vehicle Accounting*.
- c. Handbook PO-701, *Fleet Management*.

## 42 **VMAS Processes at VMFs**

---

The VMAS includes a combination of manual and automated processes performed at the VMFs. VMFs enter source data and produce reports from microcomputers for local analysis. This automated processing at the VMFs serves the following purposes:

- a. To provide a management tool for local managers.
- b. To collect and transmit data for processing at the PDCs.

## 43 **VMAS Microcomputer at VMFs**

---

### 431 **Physical Environment**

#### 431.1 **Location**

Locate the computer in a well lit, clean, and relatively dust-free area away from doorways, cabinets, or other objects which could inadvertently bump or jar the computer. Provide the best possible environment for the computer and the operator.

#### 431.2 **Temperature**

Maintain temperature between sixty-five and eighty degrees whenever the computer is operating.

## 432 **General Operating Instructions**

### 432.1 **Hardware**

Turn off the computer processor and CRT and cover the VMAS computer whenever it is not to be used for an extended period of time. Ensure that adequate time is allowed for computer components to cool before covering. Never leave the computer in a program when it is not being used.

### 432.2 **Software**

Use only established procedures as stated in the VMAS Microcomputer Operating Guide to enter and exit programs. All VMAS programs are specifically formatted. Do not alter the programs locally. Under no circumstances can locally created programs be used in the computer. Approved changes will appear in release changes only. Bypassing the password program is prohibited.

### 432.3 **Data Transmission**

Transmit data to the servicing PDC only during the VMF's scheduled time. Notify the VMAS support center when unable to transmit.

## 44 **VMAS Responsibilities: Managers, Vehicle Programs and Vehicle Services**

---

### 441 **Selecting Personnel**

The fleet manager (either the manager, Vehicle Programs, at the division or the manager, Vehicle Services, at the MSC) is responsible for ensuring that an adequate number of VMAS operators are properly trained and that backup operators are available.

### 442 **Reviewing Source (Input) Documents**

#### 442.1 **Fleet Managers**

Output reports from the VMF computer and servicing PDC provide valuable data for gauging the effectiveness of both vehicle operations and vehicle maintenance programs. Analysis and interpretation of these reports requires that fleet managers be thoroughly familiar with the indicators that gauge the efficiency of fleet operations. The fleet manager is responsible for establishing procedures for reviewing the accuracy and completeness of computer source documents prior to receipt by the computer operator. This will provide valid and timely information for developing realistic standards. The review should include checking mathematical computations, illegible

entries, and any omitted data, such as part numbers or costs. The fleet manager must keep the following three points in mind when evaluating report indicators:

- a. The accuracy of source documents.
- b. When A/P totals are used, compare at least two or three A/Ps before considering definite action. Average the variances between A/P totals to establish a trend. Year-to-date (YTD) figures are usually more indicative of problem areas.
- c. Evaluate variances that are clearly explainable and justifiable due to extenuating circumstances. However, pursue variances which cannot be justified until resolved.

#### 442.2 **Fleet Manager/Source Originator**

The individual preparing the source document is responsible for making necessary corrections required by the fleet manager.

#### 442.3 **Fleet Manager/Computer Operator**

The fleet manager is responsible for ensuring that the computer operator does not have to decide how data should be revised when errors or omissions are detected.

### 443 **Reviewing Local Reports**

#### 443.1 **Weekly Reviews**

##### 443.11 **Work Order Reports**

The fleet manager must account on a weekly basis for all work orders, review mechanic and garageman recorded times, review excessive parts and repair costs, and review the summary of account codes.

##### 443.12 **Employee Roster**

The fleet manager must ensure on a weekly basis that mechanic and garageman time is being recorded on work orders.

#### 443.2 **Accounting Period Reviews**

##### 443.21 **Vehicle Utilization Report**

Each A/P, the fleet manager must ensure proper utilization, check for erroneous mileages, check for acceptable miles per gallon, ensure proper vehicle assignment and accountability by Station ID, and identify low mileage vehicles to rotate vehicles and schedule services.

##### 443.22 **Vehicle Inventory Report**

Review each A/P for the same indicators as the Vehicle Utilization Report. This report also reflects YTD figures on fuel and oil usage, miles per gallon, and miles per quart.

**443.23 Fuel Tank Inventory Report**

Review on an A/P basis to ensure that purchases are entered correctly, that quantity on hand is correct, that issues are being processed correctly and in a timely manner, and that the local report balances with the PDC report.

**443.24 Parts Inventory Report**

Review on an A/P basis to ensure that the total value is correct and balances with the PDC report and that the inventory balance is not excessive.

**443.25 Parts Usage, Issue List, and Issue Audit Reports**

Review each of these reports on an A/P basis to check for repetitive repairs, defective parts, and usage trends for inventory control.

**443.3 Recurring Reviews****443.31 Parts Reorder Report**

Review on a regular basis to establish minimum and maximum balances and to reorder (requisition) parts.

**443.32 Parts Backorder Report**

Review regularly to ascertain what parts have been ordered but not received.

**443.4 Transmission Reviews****443.41 Transmission Verification Report**

Review immediately after printing to ensure all data was successfully transmitted to the PDC.

**443.42 Negative Transaction Report**

Print and review this report at least once an A/P to ensure that only valid corrections are made. Only the fleet manager is authorized to print and review this report.

**443.5 Password Programs Report**

Only the fleet manager is authorized to print or use the password programs report.

**444 Reviewing Postal Data Center Reports****444.1 Vehicle Maintenance Cost Report in Dollars**

This report reflects the total cost, in dollars, for all postal-owned vehicles assigned to a VMF or VPO. The report is divided into the following three major cost groups, distinguished by separate account codes:

- a. Total Direct Costs.
- b. Total Distributed Overhead.
- c. Total Indirect Cost.

**444.2 Vehicle Maintenance Payroll and Fringe Benefits Report**

This report lists all employees whose time is charged to vehicle maintenance. It also lists the distribution of all workhours and those hours charged to work orders. Hours worked but not accounted for on work orders for mechanics and garagemen are charged to undistributed labor.

**444.3 Bulk Fuel/Oil Inventory (By Tank Number/Facility) Report****444.31 General**

This reports accounts for all fuel and oil received and issued during an A/P. It reflects only the data generated by the VMAS computer. The fleet manager or designee must immediately investigate and rectify discrepancies. Submit a copy of the findings to operations support.

**444.32 Purchase Entries**

Focus particular attention on the input of purchases to the microcomputer. Purchases not recorded in a timely manner will distort this report with the VMF microcomputer report.

**444.33 Duplicate Entries**

Erroneous purchases or duplicate entries will also distort this report with the VMF microcomputer report.

**444.4 Assigned Location of Vehicles Report**

This report lists all postal-owned vehicles by location and finance number and is intended as a vehicle inventory control document. To ensure accuracy and accountability, review the report regularly and make necessary corrections.

**444.5 Inventory Status VMAS Parts and Materials Report****444.51 General**

This report lists the beginning inventory, purchases, transfers in, net received, transfers out, issues, net rejections, inventory adjustments, and ending inventory for the current period and YTD of gasoline, diesel fuel, oil, and parts. The data generated on this PDC report reflects only data input by the VMAS computer.

**444.52 Total Dollar Value**

Closely monitor the total dollar value shown on this report to the VMF microcomputer report.

**444.53 Account Identifier Codes**

Ensure that correct Account Identifier Codes (AICs) are used by the VMF and finance section for posting and payment of purchases and issues.

**444.54 Discrepancies**

The fleet manager or designee must investigate and rectify discrepancies. Submit a copy of the findings with supporting documents to the DP at the division.

**444.6 Make/Model and Component Cost Report**

This report compiles all costs involved in operating and maintaining the Postal Service vehicle fleet, including vehicle depreciation.

**444.7 Vehicle Utilization by Make/Model Report**

This report deals primarily with the number of days and hours vehicles are used during each A/P. It also lists YTD figures for cost per mile, cost per hour, and cost per vehicle.

**444.8 Fuel and Oil Usage by Make/Model Report**

This report provides data to monitor fuel and oil usage for all vehicles by make/model.

**444.9 VMAS Rejected Transaction List Report**

This report lists all transactions rejected by the PDC. The fleet manager or designee must review rejected transactions and enter them in the correction program only to the PDC.

**445 Fleet Efficiency Indicators****445.1 General**

The following Fleet Efficiency Indicators are calculated and distributed by the PDC on a single sheet to all VMFs each A/P. These indicators provide specific data which can be used by fleet managers to gauge the effectiveness and efficiency of their fleet operations and maintenance.

**445.2 Fleet Efficiency Indicators Derived From the Vehicle Maintenance Cost Report (in Dollars)****445.21 Ratio of Total Labor for Scheduled Maintenance to Direct Maintenance/Labor**

Use the following formula: Total Labor (A/C 22) divided by the sum of A/C 22, 23, and 24 equals the percent of scheduled maintenance.

**445.22 Ratio of Total Labor Plus Contract for Scheduled Maintenance to Direct Maintenance Labor Plus Contract**

Use the following formula: Total labor (A/C 22) plus contract divided by the sum of A/C 22, 23, and 24 plus contract equal is the percent of scheduled maintenance. A figure below 60 percent in 445.21 is indicative of poorly scheduled maintenance. Investigate the reasons for a low figure and rectify and address causes.

**445.23 Ratio of Undistributed Labor to Total Direct Labor**

Use the following formula: Undistributed labor (A/C 67) divided by total direct cost-labor equals the percent of undistributed labor. Investigate a figure above 3 percent and rectify and address the causes. A figure above 3 percent indicates that mechanics and/or garagemen are not recording their workhours onto work orders to coincide with recorded timecard hours. A figure below 3 percent indicates that mechanics and/or garagemen are recording work order hours in excess of timecard hours.

**445.24 Ratio of Total Indirect Labor to Total Direct Labor**

Use the following formula: Total indirect cost-labor divided by total direct cost-labor equals the percent of indirect labor. This percentage should not exceed 60 percent. A ratio higher than 60 percent indicates staffing problems (such as too many clerical and supervisory positions or understaffing in mechanics or garagemen).

**446 Retention of Microcomputer Reports**

The fleet manager is responsible for retaining microcomputer reports according to the schedule outlined in [Exhibit 446](#).



Exhibit 446

**Retention of Microcomputer Reports**

**Retain for 1 A/P**

Work Order

Reorder for Parts Current

Station ID Current

Parts Issue List

**Retain for 3 A/Ps**

Vehicle Input Worksheet

Parts Inventory

Employee Roster

Fuel and Oil

Parts Usage

**Retain for 14 A/Ps**

Vehicle Inventory

Vehicle Utilization

Parts Issue Audit

## 45 Vehicle Accounting Codes

---

### 451 **Description**

This section contains a list and description of the two-digit account codes (AICs) used to charge labor and material costs for the maintenance and repair of vehicles. The codes are organized using: the same headings found in the Vehicle Maintenance Cost Report. Open work orders are acceptable when using A/C 27, 28, 30, 38, 39, 62, 63, 64, 65, and 91.

### 452 **Direct Maintenance and Repairs**

#### 452.1 **Account Code 22 — Scheduled Maintenance**

This A/C covers the cost of scheduled maintenance, including work generated by inspection and lubrication, the cost of body and fender work caused by ordinary wear and tear, initial preoperational service given new vehicles, and major component replacement only if the vehicle is due for scheduled maintenance service. Also, charge the maintenance necessary to return a vehicle from storage to active service to AK 22, provided the vehicle would normally be due or is past due a scheduled maintenance service. Otherwise, this is considered an unscheduled repair and must be coded to A/C 24. Charge washing and tire replacement (Labor Only) done in conjunction with scheduled maintenance to A/C 22.

**Note:** A/C 22 does not include the unloading of new vehicles, which is to be charged to A/C 92.

#### 452.2 **Account Code 23 — Road Calls**

This A/C covers the cost of making road calls (except accidents) and effecting repairs even if the vehicle has to be brought back to the garage for such purposes (includes Forms 4541, *Order-invoice for Vehicle Repair*, and Form 4543, *Vehicle Maintenance Work Order*).

#### 452.3 **Account Code 24 — Unscheduled Repairs**

This A/C reflects the cost of work generated by Form 4565, *Vehicle Repair Tag*. Separate work orders are required for each individual vehicle repaired under A/C 24. This A/C also includes repairs not specifically identified under another code.

#### 452.4 **Account Code 25 — Accident Repairs**

Charge all costs generated by an accident, including paint, body and fender work, towing, shuttle, and examination time for which the Postal Service will bear the cost, to A/C 25.

**452.5 Account Code 26 — Component Rebuilding**

This A/C reflects the cost of rebuilding components for return to stock (bench rebuilds) and includes both parts and labor. Wherever possible, charge costs to the vehicle from which the component was removed. (In some cases this may prove impractical and the charges may be prorated to the fleet—Vehicle No. 0000000.) Return rebuilt components to stock at “No Value.”

**Note:** A/C 26 should not include the cost of removing or installing the components.

**452.6 Account Code 27 — Parts and Materials, Bulk Issues**

This AK reflects the materials required in washing and repairing tires and tubes and servicing fleet batteries, chains, bulk antifreeze, bulk issues of chassis lube, transmission oil, low cost parts, and so forth, in connection with VMF operations only.

**452.7 Account Code 28 — Shuttle Time**

This AK reflects the cost (labor only) of shuttling vehicles or maintenance and repair purposes only. MVS drivers or carriers will deliver new vehicles. If done by VMF personnel, the VMF will transfer the cost to the MVS driver or carrier account. (See Handbook F-21 or Handbook F-22 for PSDS offices.) Do not use A/C 28 with A/C 23, 25, 29, 42, or 91.

**452.8 Account Code 29 — Vandalism**

This A/C reflects the cost of labor, parts, and shuttle time used to repair vehicles damaged by vandalism.

**453 Operating Supplies****453.1 Account Code 31 — Gasoline, Bulk**

The cost of gasoline issued from bulk location inventories is directly chargeable to postal-owned vehicles.

**453.2 Account Code 32 — Diesel Fuel, Bulk**

The cost of diesel fuel issued from bulk location inventories is directly chargeable to postal-owned vehicles.

**453.3 Account Code 33 — Gasoline, Commercial**

The cost of gasoline purchased from commercial service stations is directly chargeable to postal-owned vehicles.

**453.4 Account Code 34 — Diesel Fuel, Commercial**

The cost of diesel fuel purchased from commercial service stations is directly chargeable to postal-owned vehicles.

**453.5 Account Code 35 — Engine Oil, Bulk**

The cost of engine oil issued from bulk fueling location inventories is directly chargeable to postal-owned vehicles.

**453.6 Account Code 36 — Engine Oil, Commercial**

The cost of engine oil issued from bulk fueling location inventories is directly chargeable to postal-owned vehicles.

**453.7 Account Code 37 — Tires and Tubes**

Charge the cost of tires and tubes replaced from inventory on Forms 4541 and 4543 to this A/C except when charged to A/C 29, Vandalism; AK 42, Maintenance and Repairs Chargeable To Others (also includes reimbursable accidents); or A/C 43, Reimbursable Operating Supplies.

**454 Fleet Servicing****454.1 Account Code 30 — Fleet Servicing**

This A/C includes costs (Labor Only) for installing chains, batteries, antifreeze, and tire and tube repairs or mounting.

**454.2 Account Code 39 — Washing Vehicles**

The costs accumulated from Forms 4541 and 4543 (Labor Only) are covered by A/C 38. Charge washing accomplished in conjunction with scheduled maintenance service to A/C 22.

**454.3 Account Code 39 — Fueling Vehicles**

This A/C covers the cost (Labor Only) of fueling vehicles at bulk storage tanks or from mobile truck/tankers.

**455 Work Chargeable to Others****455.1 Account Code 42 — Maintenance and Repair Chargeable to Others (Except Warranty)**

This A/C includes costs for maintenance and repairs performed by a VMF. It reflects the type of expenses normally chargeable to A/Cs 22 through 29, all of which are reimbursable except A/C 28.

**455.2 Account Code 43 — Reimbursable Operating Supplies**

Charge to A/C 43 expenses of the type normally chargeable to A/Cs 31 through 34, which are reimbursable and will be billed by the PDC.

**455.3 Account Code 44 — Revenues From Reimbursement**

Charge credit reimbursements from sales and services of vehicles to A/C 44.

**455.4 Account Code 41 — Reimbursable Contractual Services**

Charge contractual repairs to vehicles that are reimbursable to A/C 41.

**456 Warranty****456.1 Account Code 45 — Warranty Repairs**

This A/C covers all warranty repairs on Forms 4541 and 4543 that are to be billed to the manufacturers by the PDC.

**456.2 Account Code 46 — Warranty Revenues**

Charge amounts collected from manufacturers for warranty repairs to A/C 46.

**457 Depreciation****457.1 Account Code 50 — Depreciation of Vehicles**

Include A/P charges for depreciation on motor vehicles to A/C 50 by the PDC.

**457.2 Account Code 51 — Vehicle Sales Expenses**

Charge all costs of preparing vehicles for sale (Forms 4541 and 4543) to this A/C.

**Note:** Prepare a separate work order (Form 4541 or 4543) for each individual vehicle.

**457.3 Account Code 52 — Gain or Loss on Sale of Vehicles**

Charge the difference between the book value and the amount collected from the sale of a vehicle by the PDC to A/C 52. A gain will show as a negative amount on the Vehicle Maintenance Cost Report.

**458 Distributed Overhead****458.1 Personnel****458.11 Account Code 61 — Supervisory Time Costs**

Include the cost of all supervisory time, except that which is chargeable to the stockroom, in A/C 61. Also charge costs of all supervisory relief time to A/C 61.

**458.12 Account Code 62 — Stockroom**

The cost of all time expended in stockroom activity by supervisors, stockroom clerk(s), and part-time stockroom employees is included in A/C 62. It also reflects time spent by mechanics, clerks, and garagemen "chasing" parts. A work order (Form 4543) must be used to record time charged to this NC.

**458.13 Account Code 63 — Clerks**

This A/C covers all clerk time except that charged to stockroom (AK 62) or chargeable to a specific work order.

**458.2 Overhead****458.21 Account Code 64 — Repairs to Shop Equipment**

This A/C covers the cost of maintenance and repair of shop equipment and tools (including contractual cost) and the issuance of replacement handtools.

**458.22 Account Code 65 — Garage Maintenance**

A/C 65 covers the cost of garage cleanup and the maintenance of building and grounds. This A/C also includes the cost of postal supplies and repairs to office equipment that are expensed by the PDC and shown under the "Contract and Other" column on the VMF Cost Report in Dollars.

**458.23 Account Code 66 — Training**

Charge the cost of all training involving VMF employees to A/C 66 for related supplies, materials, travel, and compensation for instructors.

**Note:** This A/C is to be used for "on-the-job" training only when entered on Form 4543.

**458.24 Account Code 67 — Undistributed Labor**

A/C 67 covers the cost of workhours for mechanics, garagemen, body and fender repairmen, and painters, per payroll less the cost of mechanics and garagemen, and workhours on work orders.

**458.25 Account Code 68 — Rent and/or Depreciation of Buildings**

A/C 68 covers the depreciation of buildings and the normal month-by-month expenses on leases and rental agreements covering VMF space.

**Note:** Charge space occupied by other than VMF use to the using function.

**458.26 Account Code 69 — Depreciation: Garage Equipment, Furniture, and Fixtures**

Charge A/P charges for depreciation on garage equipment, furniture, and fixtures located at VMFs to A/C 69 by the PDC.

**458.27 Account Code 71 — Travel**

A/C 71 includes the cost of travel, travel away from permanent duty station (except for training), and transportation of household effects for employees transferred to VMF installations. Charge travel to account number 51401, Sub-Account 141.

**458.28 Account Code 72 — Fuel, Utilities, and Communications**

Charge A/P charges for fuel, utilities, and communication used at VMFS to NC 72.

458.29 **Account Code 73 — Cannibalization of Vehicles: Vehicle Sales Expenses (Outside)**

This A/C covers the cost of cannibalizing vehicles (labor and materials). Also charge outside vehicle sales expenses, such as auctioneers' fees or advertising, to A/C 73.

459 **Expenses Other Than Vehicle Maintenance**

459.1 **Account Code 91 — Maintenance and Repair of Postal-Owned Equipment**

A/C 91 covers the costs attributed to operating, maintaining, or repairing postal-owned, plant, and operating equipment (non VMF maintenance equipment), the cost of services or repairs to contract vehicles when such is a contractual obligation of the Postal Service (that is, towing, emergency repairs to contractor's vehicles, and borrowed vehicles), and purchase of cargo load retaining equipment repairs at a VMF for bicycles used for mail delivery. Additionally, this A/C includes official time used by VMF employees in nonvehicle matters, that is, safety committee meetings, accident review committee meetings, some union business, welfare committee meetings, and so forth.

**Note:** Parts or labor used on postal-owned vehicles must not be charged to this account.

459.2 **Account Code 92 — Evaluation, Experimentation, and Modification**

A/C 92 covers vehicle maintenance costs (labor and materials) expended on evaluation and experimentation projects and modifications to vehicles that are authorized only by the Office of Fleet Management. Additionally, record labor and materials used in unloading new vehicles in A/C 92.

459.3 **Account Code 93 — Paid Leave Variance**

The difference between the actual cost of paid leave and the amount accrued on an estimated basis by the PDC is covered by A/C 93.

## 46 Account Identifier Codes

---

### 461 Definition

This list contains only those account identifier codes (A/Cs) of interest to the VMF. See Appendix A of Handbook F-1, *Post Office Accounting Procedures*, for a complete list of all AICs and a brief description of each.

### 462 Receipt AICs

#### 462.1 Trust Funds Received — AIC 080

This receipt AIC is limited to funds received that are subsequently classified to other receipt AICs or refunded to the person from whom received.

#### 462.2 Sale of Vehicle Supplies and Services — AIC 151

AIC 151 includes the amount received at CAG A-J post offices only for the following:

- a. The sale of unserviceable motor vehicle parts, batteries, tires, cylinders, oil, and so forth.
- b. Refunds for oil drums or other containers returned to suppliers.
- c. Damage to vehicles.

#### 462.3 Reimbursement for Damages to Vehicles — AIC 162

A/C 162 includes amounts collected or receivable for damage to postal-owned trucks or other vehicle equipment.

### 463 Disbursement AICs

#### 463.1 Postal Supplies and Services

##### 463.11 Postal Supplies (VMF) — AIC 550

AIC 550 consists of authorized expenditures made by the local post office on behalf of a VMF for the following:

- a. Supplies and materials such as light bulbs, steel wool, insecticides, handtools, rakes, saws, and stepladders.
- b. Parts used to repair equipment such as adding machines, typewriters, calculating machines, letter boxes, office furniture, and mail handling equipment.
- c. Supplies such as medical supplies, lumber, glass, flashlights, and flashlight batteries.
- d. Supplies such as installation, alteration, and repair of specialized equipment.
- e. Tachograph charts used in tractors.



**463.12 Postal Services (VMF) — AIC 584**

AIC 584 consists of authorized expenditures made by the local post office on behalf of a VMF for:

- a. Services such as laundering towels, treating sweeping cloths and mops, ash and trash removal, washing windows, snow and ice removal, and repairs to building maintenance items such as lawn mowers, floor machines, and vacuum cleaners.
- b. Services used to repair postal-owned equipment such as adding machines, typewriters, letterboxes, office furniture, mail handling equipment, changing safe or vault combinations, moving of postal-owned equipment other than that authorized by maintenance mechanics, and repairs to tachograph not covered by warranty provisions.
- c. Expenditures for labor hired locally for area maintenance mechanics as authorized by Director, Office of Procurement, to assist in the installation, alteration, and repair of specialized equipment or such work as authorized by the Chief, Engineering Branch.

**463.13 Fee for Services, Postal Operations — AIC 587**

AIC 587 includes payments for services provided in connection with fitness-for-duty medical examinations and fees paid to state and local governments for furnishing copies of motor vehicle records.

**463.14 Equipment Rental (VMF) — AIC 613**

AIC 613 consists of expenditures for equipment rentals made by the local post office on behalf of a VMF.

**463.2 Vehicle Supplies and Services****463.21 Vehicle Supplies Expensed — AIC 594**

AIC 594 includes purchases at CAG A-G post offices for up to three gallons of gasoline by drivers of vehicles and the washing of vehicles at coin-operated carwashes.

**463.22 Vehicle Sales Expenses: Advertising Sale — AIC 595**

AIC 595 consists of expenses for printing sale leaflets.

**463.23 Vehicle Service and Maintenance — AIC 604**

AIC 604 consists of repairs and maintenance work for a commercial garage and other contractual services.

**463.24 Vehicle Repair Parts and Materials — AIC 614**

Use AIC 614 to record local purchases of vehicle inventory parts and materials. Use this code only at post offices with a VMF.

**463.3 Utilities****463.31 Electricity (VMF) — AIC 555**

AIC 555 includes expenditures for metered charges for electricity made by the local post office on behalf of a VMF.

**463.32 Oil Heating — AIC 565**

AIC 565 includes expenditures for authorized purchases of gas for heating made by the local post office on behalf of a VMF.

**463.33 Gas Heating — AIC 570**

AIC 570 consists of expenditures for authorized purchases of gas for heating made by the local post office on behalf of a VMF. (See AIC 565 for further definition.)

**463.34 Other Heating — AIC 580**

AIC 580 consists of expenditures for heating materials such as wood, coal, steam, and so forth, made by the local post office on behalf of a VMF.

**463.35 Water — AIC 575**

AIC 575 includes expenditures for water made by the local post office on behalf of a VMF.

**463.36 Sewage, Garbage, and Other Disposal — AIC 582**

AIC 582 consists of expenditures for utility services such as sewage, garbage, and so forth, made by the local post office on behalf of a VMF.

**463.4 Travel and Training****463.41 Travel for Training (Inside USPS) — AIC 646**

AIC 646 consists of necessary local transportation in connection with training conducted inside the Postal Service.

**463.42 Travel for Training (Outside USPS) — AIC 683**

AIC 683 includes the cost of necessary local transportation in connection with training outside the Postal Service.

**463.43 463.43 Training Instructor Fees (VMF) — AIC 686**

AIC 686 includes expenditures for instructors on a contract or fee basis made by the local post office on behalf of a VMF.

**463.44 Training Supplies and Materials (VMF) — AIC 687**

AIC 687 includes expenditures for textbooks and other supplies for training purposes made by the local post office on behalf of a VMF.

**463.5 Communications****463.51 Telephone (VMF) — AIC 560**

Expenditures for telephone services made by the local Post Office on behalf of a VMF.

**463.52 TWX, ARS, and Other Telegraphic Expenses (VMF) — AIC 618**

AIC 618 includes expenditures for TWX, ARS, and other telegraphic services made by the local Post Office on behalf of a VMF.

**463.6 Trust Funds Withdrawn — AIC 480**

The amount withdrawn from trust previously established by AIC 080.

**463.7 Tolls and Ferriage — AIC 540**

AIC 540 includes amounts paid for bridge, ferry, and highway tolls used in local transportation as evidenced by the tolls and ferriage receipts of Form 7444.

**463.8 Energy and Safety Projects (VMF)****463.81 Energy Projects Expenses — AIC 620**

AIC 620 consists of materials, labor, and services that reduce energy consumption and promote energy efficiency. This includes items for weatherproofing buildings and improving lighting, heating, ventilating, and air-conditioning efficiency. This does not include vehicle-related costs.

**463.82 Safety Projects Expenses — AIC 629**

AIC 629 includes expense projects that are necessary to correct safety hazards or eliminate the potential for accidents at the VMF. Cost will include design, construction, and installation expenses. This does not include vehicle-related costs.

## 47 FEDSTRIP Definitions and Funding Codes for VMF Use

---

### 471 **Definition**

The following definitions are reprinted from Handbook AS-701, *Material Management*. A partial listing of definitions is provided below to assist postal personnel in distinguishing between postal supplies and custodial supplies for selecting the proper fund code.

### 472 **Custodial Supplies—Fund Code “2”**

#### 472.1 **Cleaning Supplies**

Cleaning supplies such as brooms, brushes, dust pans, cloths, mops, chamois skins, sponges, receptacles, dusters, polish, floor finishes, floor machine pads, garden hose, detergents, and buckets.

#### 472.2 **Washroom Supplies**

Washroom supplies such as disinfectants and deodorants, toilet tissue, towels and towel cabinets, soap dispensers, and hand soap.

#### 472.3 **Other Supplies**

Other supplies such as lumber, clocks, manual sweepers, hand lawn mowers, air conditioner filters, laboratory supplies, manual handtools, window blinds, floor matting, parking signs, lubricating oil (other than motor vehicle), extension cords, and glass.

### 473 **Postal Supplies—Fund Code “5”**

#### 473.1 **Office Supplies**

Office supplies such as bindery supplies, binders and folders, clips and staples, erasers, index and guide cards, ink, twine knives, numbering machines, tape, glue, memo pads, pens, and pencils.

#### 473.2 **Packing Supplies**

Packing materials such as corrugated and paper boxes, wooden boxes, wrapping paper, and sealing tape.

#### 473.3 **Photography Supplies**

Film and photographic supplies.

#### 473.4 **Paper Supplies**

Paper products such as blotting paper.

**473.5 Tray Supplies**

Plastic and fiberboard trays.

**473.6 Protective Clothing Supplies**

Protective clothing such as safety devices.

**473.7 Miscellaneous Supplies**

Cash and stamp boxes, civil defense supplies, envelopes, flags, medical supplies, publications, counter signs, label holders, pallets, and timecard racks.

**474 Parts for Inventory — Fund Code “S”**

Stock of replacement parts and supplies required in the maintenance of postal vehicles.

**475 Quick Reference Guide for VMF Revenues and Disbursements**

[Exhibit 475](#) lists account codes (A/Cs), account identifier codes (AICs), form/action codes (F/ACTS), and FEDSTRIP codes as a quick reference guide for fleet managers and other VMF personnel given the responsibility of processing purchase documents, ordering inventory and expendable supplies, and acting as the contracting officer’s representative (COR).

Exhibit 475

**Quick Reference Guide for VMF Expenditures and Reimbursements**

	<b>Account Number for Purchase Order/Reimbursements</b>	<b>AIC for Cash Purchase</b>	<b>FEDSTRIP Code (SF 344)</b>
<b>Inventory</b>			
Parts	84351.007 F/ACT 1192	614 (D)	S
Bulk Gasoline	84351.007 F/ACT 1190	None	None
Bulk Oil	84351.007 F/ACT 1191	None	None
Diesel Fuel	84351.007 F/ACT 1193	None	None
<b>Expense</b>			
Custodial Supplies	52173	550 (D)	2
Custodial Services	52313	584 (D)	None
Postal Supplies	52152	550 (D)	5
Postal Services	52313	584 (D)	None
Vehicle Supplies Expensed	52151	594 (D)	None
Reimbursement for Damage to Vehicles	54913	162 (R)	None

# 5 Stockroom Management

## 51 Overview

---

### 511 Purpose

The purpose of the supply section is to order, stock, and issue parts and supplies according to established procedures.

### 512 Responsibility

The chief of supplies or designated employee is responsible for the supervision and functioning of the stockroom. This includes maintaining a stock of replacement parts, supplies, and equipment required in connection with the maintenance of postal-owned vehicles.

### 513 General Guidelines

Use Publication 41, *Procurement Manual*, Handbook AS-701, *Materiel Management*, Handbook 703, *Field Guide to Purchasing and Requisitioning*, Handbook AS-707, *Procurement Handbook*, Handbook AS-707-A, *Contracting for Vehicle Maintenance Agreements*, Handbook AS-707-B, *Contracting for Vehicle Washing and Polishing Agreements*, as VMF procurement guides. Additional instructions are issued periodically in Fleet Management Bulletins from the Office of Fleet Management.

## 52 Types of Supply Items

---

### 521 Motor Vehicle Parts and Supplies

#### 521.1 Supply Sources

The Office of Fleet Management, in conjunction with the Procurement and Supply Department, issues annual contracts for selected motor vehicle parts and supplies. Items available from these sources include tires, silicone brake fluid, and repair parts. Where greater discounts are offered by contractors for higher value orders, VMFs must structure their ordering frequencies to obtain the most advantageous price available. If a VMF is unable to meet a contract requirement, two or more VMF offices may combine orders to achieve the high discount.

**521.2 Ordering Instructions**

Use Form 4508, *Vehicle Maintenance Facility Inventory Order*, and Form 4508-A, *Continuation Sheet*, to order against these contracts. Detailed instructions for the use of these forms are covered in Fleet Management Bulletins. As other commodities are included, ordering instructions will be issued in Fleet Management Bulletins by the Office of Fleet Management. Publication 112, *Repair Parts Catalog*, outlines (in microfiche format) ordering procedures. Publication 184, *Items on Supply*, provides (in microfiche format) a cross-reference of original equipment manufacturer (OEM) part numbers to national stock numbers. Use Form 4984, *Repair Parts Requisition*, to order parts from the Topeka Materiel Distribution Center.

**Note:** Publications 112 and 184 are no longer listed publications, but are microfiche catalogs distributed directly to VMFs by the Topeka Materiel Distribution Center.

**521.3 Local Purchase**

A supervisor's signature is required on the original copy of an invoice for payment certification.

**522 Exchange Assemblies and Rebuilds****522.1 Supply Sources****522.11 Local Contracts**

If it is determined that rebuilding starters, alternators, and transmissions is not economically feasible at the VMF and that exchange assemblies are not available under Federal supply contract, VMFs should enter into a local contract for exchange assemblies. Such contracts must provide warranty provisions. The use of new or exchange carburetors and fuel pumps is optional. Local exchange unit records must reflect use of applicable warranties and monitor exchange parts failure rates.

**522.12 Basic Pricing Agreements**

When procurement of rebuilt engines is considered economically advantageous over new short blocks, or new engine assemblies and rebuilds are not available under Federal supply schedules, request the establishment of a formal contract or Basic Pricing Agreement (BPA).

**522.2 Ordering Instructions**

Procedures for vehicle maintenance service contracts are covered in current Regional Instructions and Fleet Management Bulletins issued by the Office of Fleet Management.



**523 Cannibalization**

Cannibalizing is normally the most expensive type of vehicle disposal, considering the high cost of labor and the short life of used parts not needed or never used. New parts are normally readily available at discount prices, guaranteed, and a better buy in the long run. Before deciding to cannibalize, consider all factors carefully and provide justification on Form 4587, *Request to Repair, Replace, or Dispose of Postal-Owned Vehicle*. Consider also the loss of revenue from sales. Do not issue an SF 97 or 97-A when the residue of a cannibalized vehicle is sold as scrap or salvage. When a vehicle is to be cannibalized, perform the following procedures:

- a. Accomplish cannibalization within ten days of the decision to cannibalize.
- b. Clean and paint salvaged parts and/or assemblies as appropriate.
- c. Rebuild all salvaged parts and/or assemblies as appropriate.
- d. Tag and return to stockroom inventory all salvaged parts and/or assemblies.
- e. Dispose as junk all residual parts and/or assemblies that are not to be salvaged.
- f. Do not store salvaged parts and/or assemblies in an unsecured area.
- g. Use salvaged parts and/or assemblies prior to issuing new or rebuilt parts and/or assemblies.

**524 FEDSTRIP Supplies**

The fleet manager will process Federal Standard Requisitioning and Issue Procedures (FEDSTRIP) on SF 344, *Multiuse Standard Requisitioning/Issue System Document*. See Handbook AS-701, *Materiel Management*, for detailed ordering procedures.

**525 General, Office, and Medical Supplies**

General office supplies, medical supplies (first aid), and publications and handbooks can be obtained as instructed in Publication 223, *Directives and Forms Catalog*, or Publication 24, *Supply Catalog*. Note carefully the instructions for obtaining publications and handbooks in Chapter 1, part 120 of Publication 223.

## 53 Physical Arrangement and Storage of Supply Items

**531 Physical Arrangement**

Conspicuously letter aisles A, B, C, etc. Starting at the top drawer or shelf, label each drawer or row of shelves in a storage unit A, B, C, etc. Number the bin units 1, 2, 3, 4, etc., consecutively; or, starting at the front of the stockroom, use odd numbers 1, 3, 5, etc., on the left side and even numbers 2, 4, 6, etc., on the right side of each aisle. Place each number at the top center of each

bin. Attach bin labels showing the part number to each bin or drawer section. Provide adequate racks for storing batteries and tires in standing position. Provide for rotation of stock. Where possible, place bulky items that cannot be stored in bins or racks on pallets against the wall (spring assemblies, drive and axle shafts, tail pipes, and engines and transmissions) in an orderly manner. Keep aisles clear of obstructions. Store material in bins so as not to present accident hazards. Do not store any materials on top of bins. Store parts in bins within each component group to the maximum extent possible. It is not necessary, however, that groups be in numerical order. Normally, place the groups with the fastest moving parts adjacent to the issue window.

## 532 **Low Cost Bulk Items**

### 532.1 **Definition**

For stockroom recording purposes, low cost, common use multi-purpose items are items which the value of normal issue quantity for one repair action does not exceed approximately \$2. Spark plugs are an example of an item which, while having unit value of less than \$1, should not be issued on a bulk basis since normal replacement action would involve 4, 6, or 8 units with an aggregate value greater than \$2. Also, do not expense parts (excluding gaskets) for components such as transmissions, engines, and so forth. Low cost, common use multi-purpose items include but are not limited to the following:

- a. Nuts and bolts.
- b. Small springs.
- c. Light bulbs.
- d. Flashlight batteries.
- e. Gaskets (individual).
- f. Wiper blades.

### 532.2 **Physical Arrangement of Low Cost Items**

#### 532.21 **Open Receptacles**

Place low cost items, such as nuts and bolts, in open receptacles in the shop area for free access by mechanics. Carry backup inventory as normal inventory.

#### 532.22 **Within Stockroom Enclosure**

Retain low cost items, such as tail-light bulbs and flashlight batteries, within the stockroom enclosure for control purposes. Provide open bins near the stockroom window for issue to VMF personnel without requisition by work order. Carry reserve or bulk stock of low cost items as normal inventory until such time as a quantity is moved to the free issue stock. At that time, the entire value of the quantity moved will be charged to an open work order and shown as an issue.

**532.3 Recording Low Cost Items**

Do not record issue of common use, low cost repair parts and materials on individual vehicle work orders. Stock records will be relieved of low cost items upon their issuance in bulk by recording on open work orders for servicing VMF vehicles. This provides a record of activity without requiring individual pricing, recording, and summarizing of low cost items.

## 54 Stockroom Maintenance and Control

---

**541 General****541.1 Existing Stock**

Economical maintenance of the vehicle fleet requires that parts and materials required for maintenance actions be readily available when needed. Stockrooms must be established at every VMF. The VMAS serves as a resource for perpetual inventory and proper accounting records. Make continuing partial physical inventories on a spot-check basis to prevent the accumulation of surplus stock, obsolete parts and supplies, deterioration, and pilferage.

**541.2 New Inventory Items**

Determine initial stock levels for new items of inventory by anticipated usage. These levels will remain in effect until sufficient history of use is developed to activate VMAS computer-generated maximum and minimum stock levels.

**541.3 Adjusting Stock Levels**

The stock levels set by the VMAS computer must be used, except for seasonal use items such as snow chains, block heaters, wiper blades, and de-icing fluids, or for rebuilt items, such as starters. Should operational needs dictate adjustments to the minimum or maximum stock levels, the fleet manager has the authority to approve such adjustments.

**542 Stockroom Procedures****542.1 Recording Part Numbers**

List automotive parts in the microcomputer by vehicle manufacturer's part number; for example, a generator secured from Autolite for a Dodge vehicle will be stocked under the applicable Dodge part number. Show the vendor's part number and national stock number for use in placing orders with vendors other than the vehicle manufacturer's representative.

**542.2 Recording Additions (Microcomputer)**

Record each item of repair parts or maintenance material received by the VMF in the microcomputer, regardless of whether the item is placed in stock, is immediately placed on a vehicle, or was provided at no cost to the Postal Service. Establish the practice of receiving parts and materials in the

stockroom, where practicable, to ensure that the stockroom clerk will have proper knowledge of receipts. Insert unit purchase price in the appropriate column in the microcomputer. Insert quantity received in the "Received" column. When all items have been posted, stamp "Posted" on the retained copy of Form 4686, *Shipping Order or contractor's invoice(s)*.

### 542.3 **Determining Inventory Unit Price**

#### 542.31 **General**

Unit price will be the price shown on the invoice, averaged by the microcomputer.

#### 542.32 **Outside Commercial Rebuilding of Inventory Items**

Parts or assemblies that are rebuilt or reconditioned outside the VMF by commercial contractors and placed in stockroom inventory will be carried in the microcomputer at the cost of such reconditioning, following proper procedures for purchased items. Exclude items charged to A/C 64 on Form 4541, *Order-Invoice for Vehicle Repair (Commercial Work Order)*.

#### 542.33 **Inventory Items Obtained at No Cost**

Inventory parts obtained at no cost to the Postal Service include cannibalized parts, used parts, parts rebuilt under A/C 26, or parts obtained from other agencies. Before placing in inventory, tag these parts with Form 4538, *No Value Item*. Place these parts into inventory under the OEM part number. Enter these parts with a zero dollar value, which will result in reducing the new part average price. Make every effort to issue tagged parts before issuing new parts.

#### 542.34 **One-Time Purchase Inventory Items**

A one-time purchase of a part(s) required to accomplish a single repair, which is not intended to be reordered, will be entered into the microcomputer, charged out in the normal manner, and deleted at the beginning of the next A/P.

### 542.4 **Recording Issuances (Microcomputer)**

#### 542.41 **Microcomputer and Work Order Entries**

##### 542.411 **From Work Orders**

Post all issues of stock from work orders to the microcomputer during available time when there is no activity involving the stockroom.

##### 542.412 **From Microcomputer**

At the same time that the posting is made, transcribe the unit inventory price from the microcomputer to the work order. This will serve as a record that the posting was made.

##### 542.413 **Price Extensions on Work Orders**

To avoid delaying mechanics at the parts issue window, do not make price extensions on work orders at the time of issuance. Price the work on Form 4543, *Vehicle Maintenance Work Order*, during the reduction of parts from the microcomputer inventory.

**542.42 VPO Stock Entries**

When fast moving parts, such as fan belts, oil filters, spark plugs, brake shoes, and the like, are sent to a VPO for stock, the VMF must record the shipment on Form 4543. Send a copy of Form 4543 with the parts so that the person receiving the parts at the VPO can sign and return it. The VPO must maintain a stock record, Form 4529, *Perpetual Inventory Parts*, for all parts in stock. When parts are installed on a vehicle, list the vehicle number on Form 4529. The VMF will use the vehicle number to charge VMAS procedure to the correct office.

**542.5 Recording Returned Items****542.51 To Stock**

Deduct items returned to inventory by mechanics and VPOs from the original work order. When the Form 4543 has been entered into VMAS, make a correction to remove the improper charge from the vehicle and return the item to inventory.

**542.52 To Materiel Distribution Centers**

Return items obtained from the materiel distribution centers in accordance with their current instructions (refer to Chapter 6, Handbook AS-701).

**542.53 To Vendors**

Obtain a credit memorandum for the returned material or forward to the PDC, which will deduct the amount from subsequent payments to that vendor or demand reimbursement by letter.

**542.6 Reporting Interchangeable Parts**

The fleet manager must advise the Office of Fleet Management (through channels) by memo of any interchangeable parts using the format in [Exhibit 542.6](#). The Office of Fleet Management will issue periodic cross-reference lists in Fleet Management Bulletins.

**542.7 Exchanging Obsolete Parts**

Occasionally obsolete parts, left over from a type of vehicle which is no longer in service, can be exchanged for new parts that can be used in the current fleet. This exchange usually involves a loss to the Postal Service but is still more advantageous than disposing of the unwanted parts as scrap. If no funds are involved, prepare Form 4534, *Inventory Adjustment Record and Parts Transferred Between VMFs*, in duplicate. Attach a copy of the Physical Inventory Difference Report to Form 4534. List items received in the exchange in the "Over" columns. Total the "Amount" columns. The first line entry on each form will be the statement "Parts exchange with (enter name of vendor) to relieve stock of obsolete parts." Send the original Form 4534 immediately to the New York Postal Data Center. Use the copy to update inventory in the microcomputer via the interim physical inventory program. Retain a copy of Form 4534 and the Difference Report.

Exhibit 542.6

**Parts Interchange/Parts Savings Notice**

The purpose of this document is to provide the Office of Fleet Management with two types of parts information.

- a. Interchangeability of a part from one model vehicle to another.
- b. To identify sources of less expensive replacement parts. (Report parts with savings of 20 percent or more.)

This information will then be published in a Fleet Management Bulletin to assist other VMFs in our continuing effort to reduce parts inventory costs.

Please complete the appropriate line items with the requested information.

**ORIGINAL PART**

Part Number	_____	Vehicle Model	_____
Part Name	_____		
Manufacturer	_____		
Unit Costs	_____		
Dealer/Vendor	_____		

**INTERCHANGE/PARTS SAVINGS**

Part Number	_____	List All Models the Part Fits	
Part Name	_____		_____
Manufacturer	_____		_____
Unit Costs	_____		_____
Dealer/Vendor	_____		
Address	_____		

Phone Number \_\_\_\_\_

Is this new (\_\_\_\_\_) or rebuilt (\_\_\_\_\_)

Is this a direct interchange? (Yes\_\_\_\_\_) (No\_\_\_\_\_)

If no, what modification is required: \_\_\_\_\_

\_\_\_\_\_

\_\_\_\_\_

Additional Comments: \_\_\_\_\_

\_\_\_\_\_

\_\_\_\_\_

VMF \_\_\_\_\_

Phone: \_\_\_\_\_  
Fleet Manager: \_\_\_\_\_

**542.8 Returning Defective or Substandard Parts**

Return replacement parts and material found to be defective or substandard to the commercial vendor, GSA supplier, or area supply center in accordance with current procedures. Require vendor/supplier to credit or reimburse immediately for parts determined to be substandard or defective. Enter defects in the VMAS vehicle defect reporting system. Retain one of each defective item for 45 days for shipment to the Office of Fleet Management, if requested. Provide a clear and concise reason for rejection to the vendor/supplier.

## 55 Stockroom Inventories

---

**551 General****551.1 Stock Levels**

Proper purchase and inventory controls will avoid an accumulation of surplus or obsolete parts. When considering vehicle disposal in accordance with the mileage/age criteria, review stock levels in an effort to reduce the minimum levels and other quantities. Submit a list of excess or obsolete parts and material having a unit value of more than \$0.50 and a total value in excess of \$100 to DP for possible transfer among regions. Return obsolete parts obtained from the area supply center in accordance with their current instructions. All excess or obsolete items that cannot be used in other regions, or returned to parts distributors or national contract vendors for credit on current purchases, should be disposed of on a lot basis in accordance with Chapter 3, part 358, of Handbook AS-701, *Materiel Management*.

**551.2 Mounted Tires and Batteries**

Prepare in triplicate Form 4625, *Mounted Tires and Batteries Authorized for Fleet Use*, to reflect the fleet requirements. Retain the original Form 4625 in the stockroom and post one copy each in the battery room and the tire room. When mounted tires are stored at a contractor's location for road call service, tag them as postal property and obtain a receipt, signed by the contractor, that lists the number of tires by size. Use a separate Form 4625 for each contractor and attach the receipt to it.

**552 Responsibility****552.1 VMF Supervisor**

The VMF supervisor or designated employee(s) must take a complete physical inventory under the review of the postmaster once each year. The finance office will monitor the inventory and certify the count as correct.

**552.2 Fleet Manager and Stockroom Personnel**

The fleet manager and stockroom personnel should review the Parts Usage Report on an A/P basis to identify excess or obsolete stock.

**553 Interim Inventories**

Make interim inventories on an A/P basis so that about 1/13th of the total stock is counted each A/P. More frequent counts shall be given to common use items such as tires, oil filters, spark plugs, antifreeze, tire chains, and so forth.

**554 Analyzing Inventory Differences**

Explain all single line item adjustments of \$25 or more in a narrative memorandum. Attach the original memo to the file copy of Form 4534, *Inventory Adjustment Record and Parts Transferred Between VMFs*, and retain.

**555 Reporting Inventories to the PDC****555.1 General**

Refer to Option 7, Special Functions Menu, VMAS Microcomputer Operating Guide.

**555.2 Preparing the Report**

Prepare a transmittal letter in triplicate to the New York PDC on the subject "Report of VMF Physical Inventory." Include totals for the Bulk Fuel Inventory Report. Also include the following in your report with separate totals for items b, c, d, e, and f:

- a. Date inventory taken.
- b. Total dollar amount of all parts and material per the count.
- c. Quantity (quarts) and dollar amount of engine oil per count.
- d. Quantity (gallons) and dollar amount of gasoline per count.
- e. Quantity (gallons) and dollar amount of gasoline per count.
- f. Quantity (gallons) and dollar amount of gasohol per count.
- g. The last number used in the A/P for each of the Forms 4541, *Order-Invoice for Vehicle Repair*; 4543, *Vehicle Maintenance Work Order*; and 4626, *Vehicle Fuel and Motor Oil Purchase Record*, to show your cutoff point for the inventory.

**555.3 Mailing the Report**

Mail the original letter with the originals of Form 4534, *Inventory Adjustment Record*, and the VMAS Difference Report to the PDC by Friday of the following week, along with a narrative explanation of all single line differences of \$25 or more. Give consideration to an outstanding Form 4508, *Vehicle Maintenance Facility Inventory Order*, in terms of cash purchases.



**555.4 Mailing Copies of the Report**

Send a copy of the letter(s) and a copy of each Form 4534 to DP. Retain the third copy of the letter with copies of Forms 4534 and the explanation of differences for the VMF File.

## 56 VMF Equipment and Tools

---

**561 General**

To facilitate inventory and replacement, maintain a Form 1627, *General Purpose Ruled Form*, in the stockroom. Record on this form all expendable and special tools kept in the tool crib or body shop costing more than \$50 which are not recorded on the capital equipment list or Form 4597, *Issuance of Tool Kit-Auto Mechanic*.

**562 Stockroom Responsibility****562.1 Managers, Vehicle Programs and Vehicle Services**

The local fleet manager (either the manager, Vehicle Programs, at the field division or the manager, Vehicle Services, at the MSC) must provide instructions and controls for the issuance of tools required by VMF employees. Procure necessary special tools required for body work, automatic transmissions, painting, etc., at each VMF.

**562.2 Tour Supervisors**

Repair shop tour supervisors are responsible for the tool room when stockroom personnel are off duty.

**562.3 Stockroom Personnel**

Stockroom personnel are responsible for issuing and receiving tools when on duty.

**563 Tool Kits — Automotive Mechanic Handtools****563.1 Assigning Tool Kits**

See the National Agreement, Article 39.3, Special Provision, Section 3A, and Article 28, Section 3.

**563.2 Issuing Tool Kits**

Furnish a list of tools in each kit (Form 4597) indicating the nomenclature, size, and quantity. Each eligible employee must acknowledge receipt of the tools by signing the list, which becomes a receipt. Furnish one copy of the list to the employee. The fleet manager or designated supervisor will return the signed copy. If a local need exists, it is permissible to mark each tool with the employee's tool check or another number for identification.

**563.3 Liability for Tool Kits**

Employees are responsible for all tools in their kits. Replacements will be made on the basis of need. Replace lost tools and make a record of such replacements. Employees will be financially responsible for lost tool replacement costs where loss is the result of willful or deliberate misconduct. Such losses will be charged to employees at the current Sears catalog price, which has been determined to represent the national average price range. The local fleet manager is required to obtain and maintain current price lists for these tools. Follow existing reimbursement procedures. Replacement in kind is permitted.

**563.4 Commingling of Tool Kits**

Commingling of employee tools with those issued by the Postal Service is not permitted. All tools required by the employee for the performance of one's duties will be furnished by the Postal Service.

**563.5 Replacing or Adding to Tool Kits**

Charge procurement of these tools to account number 52152 if purchased on BPA or to AIC 550 if purchased by cash. Record tools carried in stock on individual Forms 4529, *Perpetual Inventory Parts*. These are direct expense items and not carried in the VMAS inventory. Each VMF will order individual replacement tools as necessary. Make every attempt to procure tools that have manufacturer's replacement warranties. (Examples would include Snap-On, MAC, Sears, or equivalent products that provide replacement warranties.) Base reserve stock on high mortality tool items. Annual replacement should not exceed a 15 percent monetary value of all kits assigned to each VMF. Record these tools on individual Forms 4529 and issue as necessary, showing the tool kit number to which the item was issued. When unsatisfactory handtools are received, return them to the source for credit or adjustment. The local fleet manager is responsible for complying with the National Agreement.

**564 Tool Inventory****564.1 Complete Tool Kits**

Complete kits may be procured locally as needed. Make every attempt to procure tools that have manufacturer's replacement warranties. (Examples would include Snap-On, MAC, Sears, or equivalent products which provide replacement warranties.) Issue kits using Form 4597. Use Form 4529 to record complete kits, at no cost, and show to whom the kit was issued.

**564.2 Individual Tool Replacements**

Post individual items issued for replacement in tool kits on Form 4529. Show the tool kit number to which the item was issued.

**564.3 Additions to Tool Kit**

Do not change the automotive mechanic tool kit, except by specific direction of the local fleet manager, after coordination with DP at the region.

**564.4 Verifying Tools On Hand**

Once each year employees who were issued tools must sign the reverse side of Form 4597 to indicate that all of the tools are on hand. Make periodic spot checks of issued tools.

## 57 Equipment Maintenance

---

**571 Establishing a Maintenance Schedule**

Establish a maintenance schedule for all capital and expendable equipment that has a life expectancy of one year or more. Base the schedule on the manufacturer's recommended intervals. Maintenance schedules may be staggered depending on local conditions. Identify each item of equipment separately so a positive control of maintenance can be maintained. Maintain a log indicating what type of maintenance is required.

**572 Annual Equipment Inspection****572.1 Examination**

Examine all equipment annually for cleanliness and appearance. Examine all equipment once a year for proper operation. Use Form 4543 coded to AC 64 to record inspection and maintenance of shop equipment.

**572.2 Cleaning and Repairs**

Clean, paint, and repair equipment, if needed.

**572.3 Electrical Equipment**

Follow industrial color coding for electrical or hazardous equipment. Examine electrical equipment periodically for worn insulation, connections, and performance.

**572.4 Painting**

When necessary, refinish or repaint such items as work benches, stockroom bins, swingroom lockers, file cabinets, office furniture, and equipment items.

**572.5 Contract Repairs**

Use Form 4541, *Order/Invoice Vehicle Repair*, or Form 7381, *Requisition for Supplies, Services, or Equipment*, to obtain repairs to shop equipment.

**572.6 Leased Facility Repairs**

Make no repairs to basic VMF equipment, furniture, or fixtures supplied by the lessor in leased facilities without ascertaining responsibility for the cost of repairs.

**573 Surplus Equipment**

Report surplus equipment to DP at the region or division.

**574 Service and Repair Equipment**

See Exhibit 574.

**575 Test Equipment**

See Exhibit 575.

**576 Safety Equipment**

See Exhibit 576.

**577 Body Shop Equipment**

See Exhibit 577.

Exhibit 574

**Service and Repair Equipment**

Mandatory	Description	Specification	Source	Vehicles						Life Expectancy (Year)
				Up to 75	76 to 150	151 to 250	251 to 400	401 to 650	650 to Over	
	Air gun, or blow gun, level-type OSHA.		Local procurement — Dill #5114, Tru-Flate #18-232, Mechanics Choice Products #60979, or equal.	One for each mechanic.						3
	Alignment equipment, portable, front end, for aligning front axles, wheels, spindles, etc.	POD-A-390	Use latest specification. Local procurement — Wheel-O-Matic #WA 407 master set Snap-on #2054D-QA-SA set, Stewart-Warner (Alemite) #3064, or equal.	-	-	1	1	1	1	10
	Anvil, cast iron body, steel face and horn, 12-1/2" by 3-3/8" face, 5/6" hardy hole, 3/8" prichel hole.		NSN 5120-00-180-2885	-	-	1	1	1	1	10
	Battery booster cables, flexible, 9-foot minimum fully insulated copper-coated steel clamps, red and black color-coded plastic grips, polarity indicators optional.		Local procurement — Fox #BC612, Essex #78-7, Associated #6159, or equal.	1	1	2	3	3	3	3
				(One additional set for each service vehicle.)						
	Battery bus bar kit, charging circuit distribution for battery chargers with separate positive and negative leads, positive lead fuse or kickout protected, wall or bench installation.		Local procurement — Associated #6069 or equal.	-	-	1	-	1-2	2	10
	Battery charger, bench-type, series connection, for use with any combination of P-volt cells up to 36 or 72 volts dc.		Local procurement — Marquette #36-107, Associated #6073, Fox #338B, or equal.	1	1	1	-	-	-	3
	Battery charger, diode rectifier, must be used to charge batteries connected to parallel bus bar.	PS-B-485	Use latest specification. Local procurement — Associated Model #6065 or equal.	-	-	-	1	1	2	3
	Battery fast charger, portable, 6- or 1 P-volt batteries with booster-start capabilities, 11 O-I 1.5 volts ac input; breaker protection, automatic alternator protector, and high and low rate control.		Local procurement — Allen #43-010, Marquette #32-135, Associated #6001, Fox #3068, or equal.	Must be justified.						
	Battery filler, cylindrical, 2-quart water container with handle and right-angle offset spout, made of acid resisting material, automatic valve.		NSN 6140-00-752-2184	1	1	2	2	3	4	3

(Every VMF is required to have at least one of each item marked with an "\*\*".)

\*\*Hone stones and brush-type hones wear and are expendable, depending on usage. Replacements are available.

Mandatory	Description	Specification	Source	Vehicles						Life Expectancy (Year)
				Up to 75	76 to 150	151 to 250	251 to 400	401 to 650	650 to Over	
	Battery acid neutralizer for spilled electrolyte.	OSHA 29 CFR 1910.178								
	Battery tester (hydrometer), to determine specific gravity of electrolyte in lead-acid storage batteries.		NSC 6630-00-I 71-5126	1	1	1	2	3	4	3
	Face shield, aprons, and rubber gloves for handling battery acids must be provided.	OSHA 29 CFR 1910.178, 1926.304								
	Bench-mounted holding fixture, holds and positions transmissions, rear axle differentials, and other components.		Local procurement — Owatonna #7020 or equal.	-		1	1	1	1	10
	Bench, work, metal, approximately 72" L, 28" D, 34" H, with 6" backboard no drawer (drawer available as separate item if desired).		Local procurement — Equipto #2423-6, Frick-Gallagher #9058, Angle Steel #6374, Bernard Franklin #62,6240, or equal.	6	8	10	15	15	15	10
	Bleeder, brake, hydraulic, diaphragm type, 1-gallon or more container, with valve, hose, gauge, dispensing nozzle, and appropriate adapters.		Local procurement — Ammco #7400 or equal.	1	1	2	2	3	3	3
*	Brake caliper piston pliers for disc type brakes.		Local procurement — Ammco Model #9880 or equal.	One for each eligible employee.						5
	Brake caliper hone for disc type brakes; flexible drive, three-stone, range 1-1/2" to 3-1/2" diameter bores.		Local procurement — Ammco Model #9575 or equal.	One for each eligible employee.						-
	High efficiency particulate filter vacuum cleaner specifically designed to remove dust and asbestos fibers from brake shoes and drums.	MI-EL-810-81-6								
*	Brake cylinder hone for drum type brakes, flexible drive, three-stone, range 3/4" to 1-1/2" diameter bores.		Local Procurement — Ammco Model #1650 or equal.	One for each eligible employee.						-
	(or)		(or)							

(Every VMF is required to have at least one of each item marked with an "\*\*".)

\*\*Hone stones and brush-type hones wear and are expendable, depending on usage. Replacements are available.

Mandatory	Description	Specification	Source	Vehicles						Life Expectancy (Year)
				Up to 75	76 to 150	151 to 250	251 to 400	401 to 650	650 to Over	
	Brake cylinder flex-home (brush type) for drum type brakes:		Local procurement	1	1	1	1	2	2	-
	7/8" diameter		Hastings #1738 or equal.							
	1-1/8" diameter		Hastings #1739 or equal.							
	1-3/8" diameter		Hastings #1740 or equal.							
	1-5/8" diameter		Hastings #1372 or equal.							
	2" diameter		Hastings #1741 or equal.							
*	Brake drum and disc lathe. <b>Note:</b> When turning 13"-28" diameter drums with dual wheels attached to the drums, heavy-duty lathe accessories may be required.		Local procurement — Ammco #40 Mobile Brake Shop or equal.					2		10
	The following brake servicing equipment, enclosed in parentheses, should be purchased if not included in on-hand (above type) Mobile Brake Shop.									
	(Brake drum micrometer, range 6" to 16-1/8".)		Local procurement — Ammco Model #8500 or equal.					2	2	5
	(Extension bar to increase range of above micrometer to 26".)		Local procurement — Ammco Model #8539 or equal.					2	2	5
	(Checking gauge for above micrometer.)		Local procurement — Ammco Model #9582 or equal.		1		1	2	2	5
*	Bushing remove and inserter set, in metal case.		NSN 5120-00-089-3660							3
	Cabinets, tool, mechanic's, metal, 4-drawer, front panel, size 29" wide, 33" high, 19 1/2" deep, lower storage compartment, with casters and caster brakes, or as needed for standard and metric handtools.		NSN 5140-00-030-6617	One for each eligible employee.						
	Cabinets, stockroom, metal, all drawers various sizes with slide-in adjusters.		Local procurement — Stanley-Vidmar or equal.	As required.						
	Can, automatic transmission fluid, graduated, flexible spout, 1 quart capacity.		Local procurement — Brookins #101-AT or equal.	1	1	1	2	2	2	3
	Can, automatic transmission fluid, graduated, flexible spout, 5 quart capacity.		Local procurement — Brookins #805-AT, Huffy #1355, or equal.	1	1	1	2	2	2	3

(Every VMF is required to have at least one of each item marked with an "\*\*".)

\*\*Hone stones and brush-type hones wear and are expendable, depending on usage. Replacements are available.

Mandatory	Description	Specification	Source	Vehicles						Life Expectancy (Year)
				Up to 75	76 to 150	151 to 250	251 to 400	401 to 650	650 to Over	
	Can, oil, hand pump type, with handle, 15" bent tip spout, 1-quart capacity.		NSN 4930-00-396-1 0401	2	3	3	4	4	5	3
	Can, oil, swing type spout,									
	1-quart capacity		NSN 7240-00-634-4802	1	1	2	2	3	3	3
	2-quart capacity		NSN 7240-00-281-8516	1	1	2	2	3	3	3
	4-quart capacity		NSN 7240-00-283-6065	1	1	2	2	3	3	3
*	Can, safety, for temporary storage of gasoline spout, safety screen, and spring closure.		NSN 7420-00-240-6958	2	2	2	3	3	3	3
	Can, water, plastic, 3-gallon capacity, with spout.		Local procurement — Huffy #2104, Brookins #505, or equal.	1	2	3	3	3	3	1
	Chisel, power, air-operated, general purpose; kit includes: shock absorber chisel, sheet metal cutter, tailpipe cutter panel cutter, spot weld breaker and carrying case.		Local procurement — Black & Decker #6621, Chicago Pneumatic #CP-714, or equal.	1	1	1	1	1	2	5
*	Choke checker, duplicates cold-start conditions at engine operating temperature.		Local procurement — Owatonna #7032-K, or equal.	1	1	1	1	2	2	6
*	Cleaner, high-pressure, drum type, for cleaning engines, transmission cases and under carriage of vehicles, and for washing vehicles. Operates on 11 O-volts ac		Local procurement — Jenny MJ-BOO-C, Graco 800, L&A #813-35, or equal	1	1	1	1	1	2	5
	or		or							
	Cleaner, high-pressure, same as above, except portable.		Local procurement — L&A #813 with Handy Cart #5481, Graco #1600, or equal.	1	1	1	1	2	5	
	Cleaner, parts and units, pump agitated, tank-type, portable continuous recirculation and filtration of cleaning compound.		Local procurement — Kleer-Flo Super Cleanmaster #90, or equal.	-	-	1	1	2	2	5
	Cleaner, parts and units, pump agitated tank-type, portable, continuous recirculation and filtration of cleaning compound.		Local procurement — Kleer-Flo Cleanmaster #J-50, or equal.	1	1	-		-	-	5
	Cleaner, small parts, bench-type, air-activated.		Local procurement — Kleer-Flo #A-15, or equal.	1	1	1		2	2	5

(Every VMF is required to have at least one of each item marked with an "\*\*".)

\*\*Hone stones and brush-type hones wear and are expendable, depending on usage. Replacements are available.



Mandatory	Description	Specification	Source	Vehicles						Life Expectancy (Year)
				Up to 75	76 to 150	151 to 250	251 to 400	401 to 650	650 to Over	
	Cleaner, steam. New or replacement units may not be projected for purchase unless planned interior installation location is extremely well ventilated or exterior areas are available for installation.		Local procurement — L&A #7504, or equal.	Must be justified						
	Cleaner, steam, portable, 1/3-hp motor, 110-115 volts ac, uses propane and produces steam in 45 seconds. Dispenses solution at rate of 100 gallons per hour and 500 PSI nozzle pressure.		Local procurement Thunderbird #T-500 Clayton #180, or equal.		1			2	2	10
	Cleaning tool, piston ring groove.		Local procurement — Snap-on #RC-500, Ammco #8334, or equal.		1			1	2	3
	Cooling system automatic flush and refill machine, with pressure tester, reverse flushes and refills cooling system with required amount of antifreeze solution.		Local procurement — Union Carbide Corporation #P-69 or equal.		1			2	2	5
	Crane, portable, 1-ton capacity, folding type, hydraulic, hand pump, adjustable boom, for engine removal and replacement.	PSC-391	Use latest specification. Local procurement — Owatonna #1809, or equal.	Must be justified.						
*	Creeper, mechanics, wood with padded headrest, four angular-mounted swivel casters, minimum 35" long, 14-1/2" wide.		NSN 4910-00-251-6981	One for each mechanic. Also, one for each junior mechanic, if required						
	Cutter, bolt, adjustable, angular cut (flush cutting), 1/4" cutting capacity 14" overall length.		NSN 5110-00-224-7055	1	1	1	1	2	2	3
	Cutter, bolt, adjustable, clipper cut (close cutting, 3/8" cutting capacity, 24" overall length).		NSN 5110-00-596-91 56							
	Cutter, bolt, adjustable, clipper cut (close cutting, 9/16" cutting capacity, 36" overall length).		NSN 5110-00-1 88-2524							
	Dolly, hydraulic, for removing and replacing dual truck wheels.		Local procurement — Ajax #95765, Ken #T-203, Gwatonna #1770-A, or equal.			1	2	2	4	10
	Dolly, mechanical, for removing and replacing single wheels.		Local procurement — Sure View Incorporated #SWL072, or equal.				1	1	1	10

(Every VMF is required to have at least one of each item marked with an "\*\*".)

\*\*Hone stones and brush-type hones wear and are expendable, depending on usage. Replacements are available.

Mandatory	Description	Specification	Source	Vehicles						Life Expectancy (Year)
				Up to 75	76 to 150	151 to 250	251 to 400	401 to 650	650 to Over	
	Drain unit, waste oil (without drum), with caster (portable) base, telescoping funnel adjustable from approximately 39" to 62" height and an oil level gauge, fits 120 lb. drum.		Local procurement — Grace #255-034, Alemite #8580, or equal.	1	1	2	2	3	3	3
	Drill, electric, portable, 3/8" capacity 115 volt, single phase, double-insulated, variable no-load speed, 1,000 rpm, closed grip handle.		NSC 5130-00-293-3546	One for each eligible employee.						7
	Drill, electric, portable, 1/2" capacity, 115 volt, single phase, 650 rpm, combination breast-plate and spade end handle, with two side handles (one removable.)		NSC 5130-00-293-I 849	1	1	1	1	2	2	4
	Drill, portable, 90-degree angle 1/4" capacity, for close quarter drilling.		NSN 5130-00-293-I 977	1	1	2	2	3	4	4
	Drill press, 15" electric, bench or floor model, 3/4 hp, single phase, 110 volt, 60 cycle, variable speed, adjustable table, both horizontal and vertical, belt guard and overload shutoff.		Local procurement- Powermatic #1150 or equal.		1	1	1	1	2	12
	Drill press, magnet@, 3/4", 115 volts, 25 to 60 cycles, precision for accurate hole drilling horizontally, vertically, or overhead, safety-grip switch in handle.		Local procurement — Black & Decker #674, Type B, or equal.	Must be justified.						12
	Dust mask.		Local procurement.							
	Respirators.	OSHA 29 CFR 1910.134	Local procurement. NIOSH, MSA, or other approved respirator selected to provide protection against contaminants being used in the work process ANSI 288.2 1980.							
	Dynamometer, chassis, vehicle operational testing purposes.		Local procurement — Clayton #CT-200 or equal.	Must be justified.						10
	Fan, pedestal, nonoscillating, with approved safety guard, 30" rigid blades, 2-speed switch, 60 cycle, 110 volts ac, pedestal adjustable for height.		NSN 4140-00-833-5068	Must be justified.						10

(Every VMF is required to have at least one of each item marked with an "\*\*".)

\*\*Hone stones and brush-type hones wear and are expendable, depending on usage. Replacements are available.

Mandatory	Description	Specification	Source	Vehicles						Life Expectancy (Year)
				Up to 75	76 to 150	151 to 250	251 to 400	401 to 650	650 to Over	
	Gauge, belt tension, used to measure tension on all v-belts.		Local procurement — Owatonna (Ford) #T63L-8620 A, Borroughs #BT-33-73F (auto), #BT-33-74 (truck), Kent-Moore #323600, or equal.	One for each eligible employee.						4
*	Gauge, brake drum, for pre-adjusting brakeshoe clearance on large trucks before installing drums.		Local procurement — Ammco #9494, or equal.	As required where airbrake equipped vehicles are serviced.						5
	Gauge, brakeshoe, adjusting, for adjusting brakeshoe to drum clearance before installing drums.		Local procurement — Ammco #8650, or equal.	1	1	11		2	2	5
	Gauge, crankshaft, used to measure main bearing journals without removing shaft from block.		Local procurement — Central #260 or equal.	-	-	1	1	1	1	5
	Gauge, dial indicator, for cylinder wear measurement.		Local procurement — Starrett #452BN, Kent-Moore #38087, or equal.	-	-	11		2	2	5
*	Gauge, tire pressure, general service, heavy-duty line chuck gauge, dual-chuck foot.		NSN 491 0-00-522-3778	One for each eligible employee.						2
	Gauge, tire tread depth, graduated in 1/32" calibrations.		Local procurement — Dill #5123, Schrader #5998, Tru-flate #47-085, or equal.	One for each eligible employee.						3
	Grinder, P-wheel, bench-type, 8" stones, and/or wire brush, 3/4-hp, 115 volt motor w/toggle switch controls, guards, lights, and shield.	OSHA 29 CFR 1910.215	NSN 3410-00-528-4822	1	1	11		2	2	5
	(Lighted eye shield attachment for installation on grinding or buffer frames of above grinder.)		Local procurement — Black & Decker #C34575, Sioux #2016. Snap-on #S-115, or equal.	If original equipment does not include item, separate attachment should be procured and installed as required.						4
	(Face shield, for use by all employees when using above grinder.)	OSHA 29 CFR 1910.133	NSN 4202-00-542-2048	Assign at each grinder and body repair shop.						2
	(Pedestal, grinder, to make pedestal unit of above grinder.)		Local procurement — Sioux #680, Black & Decker #6305, Snap-on #VR-300B, Van Norman #K500HM, or equal.	1	1	1	1	2	2	5
	Sander/grinder, pneumatic, 7" wheel, air-operated, with required safety attachments.									

(Every VMF is required to have at least one of each item marked with an "\*\*".)

\*\*Hone stones and brush-type hones wear and are expendable, depending on usage. Replacements are available.

Mandatory	Description	Specification	Source	Vehicles						Life Expectancy (Year)
				Up to 75	76 to 150	151 to 250	251 to 400	401 to 650	650 to Over	
	Grinder, valve face, with stem attachment, adjustable angle, coolant tank, wheel dresser, 1/2 hp motor.		Local procurement — Sioux #2062 or equal.							5
	Grinder (kit), valve seat, including motor, driver, required grinding stones, and pilots.		Local procurement — Sioux #1725-E, Black & Decker #6337, or equal.	1	1	1	1	2	2	5
	Gun, grease, hand-operated, with flexible hose.		Local procurement — Lincoln #1013, Alemite #6243-J, or equal.	1	1	1	2	2	3	2
*	Headlamp arming kit, for alignment of headlamps.		Local procurement — Hopkins #1-1 00-03, Snap-on #B4AK, AC type H-2 (#1550503) or equal.	1	1	1	1	1	1	5
	Hoist, chain, 1/2-ton capacity, motor-operated, for installation on trolley and track, or stationary.		Local procurement — Budget #C408-6R, Coffing #JF-1032-1, or equal.	Must be justified						5
	Hoist, chain, 1-ton capacity motor-operated, with 12' A frame.		Local procurement — Coffing #WR2014-3, Budgit #D408-2R, or equal.	Must be justified						5
*	Hone, engine cylinder, glaze breaker.		Local procurement — Hastings #1053, Owatonna #CF-62-62, equal.	1	1	1	1	1	2	-
	Hose, garden, rubber, 5/8" inside diameter, 50-foot length, rolled brass couplings.		NSN 4720-00-1 03-3920	1	1	1	2	2	2	3
	Jack, floor, hydraulic, 1-1/2 ton capacity, with wheels.		Local procurement — Walker #93632, Ajax #95632, Blackhawk SJ-2, or equal.	1	1	2	2	4	6	5
*	Jack, floor, hydraulic, 4-ton capacity, with wheels.		Local procurement Walker #93657, Ajax #95657, Blackhawk SJ-4, or equal.	-	-	1	2	3	6	5
	Jack, floor, hydraulic, air-operated, 10-ton capacity, with wheels.		Local procurement — Walker #93665, Blackhawk #SJ-9, or equal.	-	-	-	1	2	3	5

(Every VMF is required to have at least one of each item marked with an "\*\*".)

\*\*Hone stones and brush-type hones wear and are expendable, depending on usage. Replacements are available.

Mandatory	Description	Specification	Source	Vehicles						Life Expectancy (Year)
				Up to 75	76 to 150	151 to 250	251 to 400	401 to 650	650 to Over	
	Jack, floor, hydraulic, air-operated, valve control, 20-ton capacity, with wheels.		Local procurement — Blackhawk #PJ-21, Walker #93731, or equal.	Must be justified						5
	Jack, lift, one end, pneumatic, 2-1/2-ton capacity, portable.		Local procurement — Blackhawk #SJ-64, Ajax #95686, or equal.	1	1	1	2	3	4	10
*	Jack stand, adjustable, 15" to 24", 5-ton capacity.		Local procurement — Blackhawk #AX50, Ajax #95516, Ken-Tool #T-1 19, Walker #93516, or equal.	8	12	16	20	24	24	8
**	Jack stand, adjustable height, 18" to 30", 10-ton capacity.		Local procurement — Ajax #95522, Watco #1 OTP, Blackhawk AX-100, or equal.	-	-	-		8	12	9
	Jack, transmission, hydraulic, high-lift on wheels, for use under hoist.		Local procurement — Wudel #711-50, Ajax #95714, Walker #93714, Blackhawk #T-2, Owatonna #1780, or equal.	-	-	1	1	1	2	9
*	Jack, transmission, hydraulic, tilt-frame, on wheels, for transmission work with vehicles on jack stands.		Local procurement — Wudel #700-50, Milwaukee #3000, Blackhawk #T-14, Owatonna #1790, or equal.	1	1	1	1	2	3	5
	Key machine, electric, 110 volt, 1/8 hp motor for cutting single-sided and double-sided keys.		Local procurement — Independent Lock (Div. of ILCO) #2584CV, or equal.	-	-	1	1	1	1	5
	Ladder, commercial safety type, for various uses around VMF, metal preferred except when performing work near electric lines and connections.		Check GSA Supply Catalog or Federal Supply Schedule for specific item.	As required						5
	Ladder safety shoes, to prevent slipping.		Check GSA Supply Catalog for specific shoes required.	As required						
*	Ladder, step, aluminum alloy, nonslip steps, bucket shelf, 8 ft. length.		NSN 5440-00-514-4487	1	1	1	2	2	2	3
*	Lifter, valve spring, C-frame style, 7/8" — 1-1/2" diameter.		NSN 5120-00-239-8686	-	-	1	1	2	2	5
	Lifter, valve spring, C-frame style, 7/8" — 2-3/4" diameter.		NSN 5120-00-529-2283	-	-	-		1	1	4

(Every VMF is required to have at least one of each item marked with an "\*\*".)

\*\*Hone stones and brush-type hones wear and are expendable, depending on usage. Replacements are available.

Mandatory	Description	Specification	Source	Vehicles						Life Expectancy (Year)
				Up to 75	76 to 150	151 to 250	251 to 400	401 to 650	650 to Over	
	Micrometer, inside, set 1-1/2" to 8" minimum.		Local procurement — Starrett #823A, Tumico #1 0-458-00, or equal.	1	1	1	1	1	1	15
	Micrometer, outside, scale graduated in ten thousandths of an inch, ranges: 0" to 1", to 2", 2" to 3", 3" to 4", 4" to 4", to 5" to 6", with ratchet stop and lock, specify standard case.		Local procurement — Starrett #T239RL, Tumico #850 Series, or equal.	1	1	1	1	1	1	15
*	Nutsert, insert fastener, with conversion kits for applicable size nutsert to be installed, provides reliable, load-bearing female threads in materials unable to support threads or in application in which ordinary nuts are impossible to use.		Local procurement — Curtis Industries #83862, or equal.	1	1	1	1	1	1	4
	Packer, wheel bearing.		Local procurement — Alemite #6709-A and 6709-B, Lincoln #842, Aro Corp. #640-072, or equal.	1	1	1	1	2	2	3
	Pan, drain, oil or water, hood baffle, carrying handles.		Local procurement — Huffy #3174, Brookins #677, or equal.	2	2	3	3	4	4	3
	Pliers, tire chain repair, removal and installation of new links, etc.		Local procurement — K-D #472 or equal.	One for each eligible employee.						3
	Press arbor, bench or side mount, approximately 3-ton capacity, including required guarding.	OSHA 29 CFR 1910.217	Local procurement — Dake Model #1 -1/2B	1	1	1	1	1	2	25
	Press, floor-type, hydraulic, 25-ton capacity, with adjustable bed, plates and gauge, including required guarding.	PS-P-484	Use latest specification. Local procurement—Blackhawk AP-25, Dake #25H, Owatonna #Y-125-A, or equal.		-	1	1	1	2	10
*	Puller, pitman arm, for removing pitman arm from steering gear.		Local procurement — Owatonna #HC 642 (medium or heavy trucks), Owatonna #643 (light trucks to 3/4 ton), Snap-on #C3-89, or equal.	1	1	1	1	2	2	3
*	Puller, steering wheel, for removing those with predrilled and tapped hubs to attach puller bolts.		Local procurement — Owatonna #915-A or equal.	1	1	1	1	2	2	3

(Every VMF is required to have at least one of each item marked with an "\*\*".)

\*\*Hone stones and brush-type hones wear and are expendable, depending on usage. Replacements are available.

Mandatory	Description	Specification	Source	Vehicles						Life Expectancy (Year)
				Up to 75	76 to 150	151 to 250	251 to 400	401 to 650	650 to Over	
	Puller, steering wheel, three-arm, 5-1/4" spread range, 3-1/8" reach, rubber bushings on pulling ring to protect spoke of steering wheel.		NSN 5120-00-449-3771	1	1	1		2	2	3
	Pump, barrel, hand operated, fits 1-1/2" to 2" openings, adjusts for 15-55 gallon barrels or drums, 40" suction pipe, delivers 10 gallons per minute.		NSN 4930-00-294-6897	As required						10
	Pump, vacuum, hand-held, checks all vacuum-operated components.		Local procurement — Owatonna #7059, or equal	1	1	1	2	2	2	5
	Racks, tire storage, single units, 2-tier (add-on unit for above) .		Local procurement Frick-Gallagher #793-2, or equal	1	1	2	2	3	4	20
			Local procurement Frick-Gallagher #793-2, or equal	As needed						20
	Reamer, ridge, triple carbide cutters, self-centering, adjustable to sizes approximately 2-9/16" to 5" with chamfering guide shoe.		Local procurement — Ammco #2100, Lisle #38000, or equal	1	1	1	1	2	2	3
	Reel, air, 30-foot, heavy-duty hose, open commercial type, spring return.	PS-F-479	Use latest specification. Local procurement — Alemite #Econo-8176, Aro #614-004, Grayco #255-805, Lincoln #83410, or equal	3	4	5	10	10	15	5
	Reel, light, 30-foot, 3-wir.e, grease resistant rubber extension case and hook.	POD-R-186	Use latest specification. Local procurement — Alemite #330004-B, Balcrank #44782, or equal	One for each work day or work area as required.						3
*	Ring compressor, hand-operated take-up with 2 tension bands and ratchet, 2-1/8" to 5" capacity.		NSN 5120-00-250-6055	1	1	1	1	2	3	3
	Ring compressor, hand-operated take-up with two tension bands and ratchet 3-1/2" to 7" capacity, for use when piston diameter exceeds 5" .		NSN 5120-00-228-8848	-	-	1	1	1	1	6
	Separator, ball joints 1" inside diameter, tapered-wedge end.		Local procurement — Snap-on #A-201 or equal.	1	1	1	1	2	2	3
*	Separator, tie rods and shock absorber links, 13/16" inside diameter, tapered wedge end.		Local procurement— Owatonna #462, Snap-on #A-200, or equal.	1	1	1	1	2	2	3

(Every VMF is required to have at least one of each item marked with an "\*\*".)

\*\*Hone stones and brush-type hones wear and are expendable, depending on usage. Replacements are available.

Mandatory	Description	Specification	Source	Vehicles						Life Expectancy (Year)
				Up to 75	76 to 150	151 to 250	251 to 400	401 to 650	650 to Over	
	Shelving, stockroom metal, adjustable shelves.		Local procurement– Bernard Franklin, Angle Steel, Frick-Gallagher, or equal.	As required.						20
	Sling, load-positioning, 2,000 lb. capacity, heavy-duty chain, swivel hooks on each end, locking adjustment at any angle, for use with 1-ton crane above. Slings must be tagged, indicating the rated capacity.	OSHA 29 CFR 1910.164	Local procurement — Owatonna #1605 or equal.	Must be justified.						10
*	Soldering gun, heavy-duty, 115 volt, 60-cycle, 240–325 W, 3-conductor cord, for general soldering requirements.		NSN 3439-00-618-6623	One for each eligible employee.						3
	Soldering torch kit, propane.		NSN 3439-00-542-0531	1	1	1	1	1	1	3
	Stand, engine overhaul, 1,000–1,500 lbs., for light and heavy-duty trucks.		Local procurement — Ajax #95774, Owatonna #1725, or equal.	–	–	–	–	1	1	10
	Stand, differential and rear axle.		Local procurement — Ken-Tool #T-123, Owatonna #1725 W/1725-P or equal.	ONLY as required.						10
	Starting equipment gasoline powered generator, portable, for emergency starting of vehicles.		Local procurement — Marquette #34-1 08, Goodall #II -708K (gas), or equal.	Must be justified						5
**	Tap and die set, NF and NC threads 1/4" to 1" diameter, six machine screw sizes 4–36 to 12–24, pipe size 1/8" and 1/4", fitted wood case.		Local procurement — Snap-on #TD-9902, or equal.	1	1		1	1	2	6
	Tank, Defueler/Refueler.		Model FM-3000 Tempo Products Co. or equal.							
	Thermometer, radiator, use for checking temperature at which the thermostat opens, stainless steel case.		Local procurement — Snap-on #GA1 34, Inland #2048,K-D #411 or equal.	1	1		2	2	2	3
*	Tire and tube testing tank.		Local procurement — Brookins #606, Huffy #3109 or equal.	1	1		1	2	2	10
*	Tire bead expander, for proper inflation for tubeless tires.		Local procurement — Bishman #500 or equal.	1	1		1	1	1	5

(Every VMF is required to have at least one of each item marked with an "\*\*".)

\*\*Hone stones and brush-type hones wear and are expendable, depending on usage. Replacements are available.



Mandatory	Description	Specification	Source	Vehicles						Life Expectancy (Year)
				Up to 75	76 to 150	151 to 250	251 to 400	401 to 650	650 to Over	
	Tire mounter and demounter, air power, for tire sizes 13" through 17".		Local procurement — Bishman #2100 or equal.	1	1	1	1	1	1	10
	Tire mounter and demounter, electric-hydraulic power, for tire sizes 15" through 24.5".		Local procurement — Bishman #931A or equal.	-	-	-	-	1	1	10
	Tire safety inflation cage, made of five 2-1/4" diameter bars of high tensile steel tubing, approximate size height 60", width 24", inside height 56-1/2", inside width 17-1/4", front to back 36".	OSHA 29 CFR1910.177	Local procurement — Branick Model SC or equal.	1	1	1	2	2	3	10
	Tire spreader, air-operated, tire sizes 12" to 24" rims.		Local procurement — Bishman Model 426 or equal.	1	1	1	-	-	-	5
	Tire spreader, air-operated, tire sizes 12" to 24" with tire lifter.		Local procurement — Branick Model V-INV/LA.	-	-	-	1	1	1	5
	Tank, air, portable, ASME approved.									
	Torque converter and oil cooler cleaner, automatic transmission.		Local procurement — Owatonna #6008a or equal.	ONE unit in each transmission overhaul center. Must be justified in other VMFs.						
	Tow chain, 3/8" links, 14 feet long, with hooks.		NSN 4010-00-1 71-7680	One per service vehicle.						
	Tow, lift unit, electric hydraulic cylinder, 5,000 lbs. lift capacity, for mounting on rear of service trucks.		NSN 2540-00-074-2875 (Hydra-Tow or equal.)	Must be justified.						10
*	Transmission band adjustment and servicing tools, required for the type of servicing provided by the facility involved and the makes of vehicles assigned.		Local procurement — Proto, Kent-Moore, Lempco, Snap-on, or equal.	1	1	1	2	3	4	6
	Tube flaring tool kit, 1/8" through 3/4" OD.		Local procurement — Imperial Eastman #375-FS, or equal	1	1	1	2	2	2	3
	Vacuum, Brake, & Clutch Ser.	OSHA Reg. 29 CFR 1910 10D1 (h)	Tempo Products Co. AB 7515 or equal.	Mandatory for each VMF equipped for brake or clutch repairs.						5
	Vacuum cleaner, floor model, heavy-duty tank style, with removable bag or container, 1 hp electric motor, 115 volt, ac/dc, 60-cycles, single phase, 10-foot hose, 25-foot hose and attachments on casters, for cleaning interior of vehicle cabs and bodies at wash rack or dispatch point.		NSN 791 O-00-267-1207	Must be justified.						5

(Every VMF is required to have at least one of each item marked with an "\*\*".)

\*\*Hone stones and brush-type hones wear and are expendable, depending on usage. Replacements are available.

Mandatory	Description	Specification	Source	Vehicles						Life Expectancy (Year)
				Up to 75	76 to 150	151 to 250	251 to 400	401 to 650	650 to Over	
	Vacuum cleaner, heavy-duty, pole or wall type, 1 hp electric motor, automatic off and on control, equipped with double switches, crush-proof accordion hose, 16 feet long for cleaning interior of vehicles at fuel islands.		Local procurement.	One at each gas pump island.						
*	Valve tool, for inserting and removing snap-in type tubeless tire valves.		Local procurement — Schrader #992 or equal.	1	1	1	1	2	2	3
	Vise, drill press, hold work on drill stand, width of jaws 3", opening 3".		Local procurement — Sioux #1553 or equal.	As required.						10
*	Vise, machinist's swivel base, rolled steel screw and handle, 4" jaw, 6" capacity.		NSN 5120-00-293-1439	2	3	4	5	10	15	10
	Vise, machinist's swivel base, rolled steel screw and handle, 6" jaw, 9" capacity.		NSN 5120-00-223-1945	1	1	1	2	3	4	10
	Welder, electric, portable, for operation on 208–220 volts, 60-cycle single or multiphase electric service. Also provide face shields, aprons, and welding gloves as necessary.	OSHA 29 CFR 1910.252	Local procurement — Forney #FS230VW or #FS295VW, Marquette #10-I 19, or equal.	1	1	1	1	1	2	10
	Welder, spot, portable, for operation on 110–115 volts. Also provide face shields, aprons, and welding gloves as necessary.	OSHA 29 CFR 1910.252	Local procurement — Marquette #14-117 wrth #14-109 welding gun or equal.	–	–	1	1	1	1	10
*	Welding and cutting outfit, oxygen, acetylene: including torch, various tips, cutting attachments, and two-stage regulators. Also provide face shields, aprons, and welding gloves as necessary.	OSHA 29 CFR 1910.252	Local procurement — Victor Super-Range #03840043, with VTS 250C-540 two-stage regulator for oxygen, and VTS 260A-510 two-stage regulator for acetylene.	1	1	1	2	2	3	5
	Welder, MIG, steel-aluminum, etc.	OSHA 29 CFR 1910.252								
	Plasma cutter.	OSHA 29 CFR 1910.252	Local procurement.							
	Wheel balancer, spinner type, 200 volts, 60 cycles, single phase, 3 hp.		Local procurement — Stewart Warner #7059-A or equal.	–	–	–	1	1	1	10

(Every VMF is required to have at least one of each item marked with "\*\*".)

\*\*Hone stones and brush-type hones wear and are expendable, depending on usage. Replacements are available.

Mandatory	Description	Specification	Source	Vehicles						Life Expectancy (Year)
				Up to 75	76 to 150	151 to 250	251 to 400	401 to 650	650 to Over	
	Wheel balancing equipment, for balancing truck wheels, bubble-type with necessary adapters for wheel sizes.	PS-B-392	Use latest specification. Local procurement — Bushman #580, Lincoln #104571, or equal.	1	1	1	1	1	1	5
	Windshield, repair kit, to be used when repairing wind-shields with star or bullseye type breaks up to 3/4" diameter.		Local procurement — Novus #200 or equal.	1	1	1	1	1	1	5
	Wrench, impact, pneumatic, 3/8" straight drive, with air volume torque regulator.	OSHA 29 CFR 1910.243	NSN 5130-00-234-4879	One for each eligible employee.						4
	Wrench, impact, pneumatic, 3/4" straight drive, pistol-grip handle, trigger throttle.	OSHA 29 CFR 1910.243	NSN 5130-00-184-1427	-	-	-	-	1	1	4
	Wrench, impact, pneumatic, 1" straight drive, with air volume torque regulator, pistol-grip handle.	OSHA 29 CFR 1910.243	NSN 5130-00-184-1426	Must be justified.						4
	Wrench socket set (impact), 3/8" square drive, hexagonal (6 point) for power tools.	OSHA 29 CFR 1910.243	NSN 5130-00-203-6442-5/16" NSN 5130-00-203-6443-11/32" NSN 5130-00-203-6444-3/8" NSN 5130-00-203-6445-7/16" NSN 5130-00-203-6446-1/2"	One set for each impact wrench in facility.						3
	Wrench socket set (impact), 3/4" square drive, includes 15 regular-length 6-point sockets, and one each 7" and 13" extension bars.	OSHA 29 CFR 1910.243	NSN 5130-00-357-5135	One set for each impact wrench in facility.						3
	Wrench socket set (impact), impact wrench 1" square drive, includes 16 regular-length 6-point sockets, and one each 7" and 13" extension bars.	OSHA 29 CFR 1910.243	NSN 5130-00-357-5136	One set for each impact wrench in facility.						3
	Wrench socket set (manual), 3/4" sq. drive, hd, 28-piece, sizes from 15/16" through 2-3/8", with one hinged handle, 17-3/4" long; one reversible ratchet handle, 17" long; one sliding T-handle; one universal joint attachment; three solid extension bar attachments, 3", 8", 16" long; and metal box.		NSN 5120-00-081-2308	-	-	1	1	1	1	3

(Every VMF is required to have at least one of each item marked with an "\*\*".)

\*\*Hone stones and brush-type hones wear and are expendable, depending on usage. Replacements are available.

Mandatory	Description	Specification	Source	Vehicles						Life Expectancy (Year)
				Up to 75	76 to 150	151 to 250	251 to 400	401 to 650	650 to Over	
*	Wrench torque, 3/8" sq. drive, to measure 0 to 300 in.-lbs. torque range.		NSN 5120-00-958-6906	1	1	1	1	2	2	5
*	Wrench, torque, 1/2" sq. drive, to measure to 250 ft.-lbs. torque range.		NSN 5120-00-640-6365							
	Wrench, torque, 3/4" sq. drive to measure 0 to 600 ft.-lbs. torque range.		NSN 5120-00-221-7983	As required for servicing large vehicles.						

*(Every VMF is required to have at least one of each item marked with an "\*\*".)*

*\*\*Hone stones and brush-type hones wear and are expendable, depending on usage. Replacements are available.*

Exhibit 575

**Test Equipment**

Mandatory	Description	Specification	Source	Vehicles						Life Expectancy (Year)
				Up to 75	76 to 150	151 to 250	251 to 400	401 to 650	650 to Over	
*	Tester, antifreeze (coolant) and battery (Prestone Vu-Chek) for (AO Duo-Chek), scale in degrees Fahrenheit, to test solution.		Local procurement — American Optical Corp. Model #7181 or equal.	One for each eligible employee.						3
	Tester, armature (growler), tests for shorts, ground, and continuity.		Local procurement — Allen #313, Sun #AT-76, or equal.	-	-	1	1	1	1	5
	Tester, battery, starter, generator, alternator, regulator.	POD-T-388	Use latest specification. Local procurement — Sun #VAT-28, Allen #21, 370, or equal.	1	1	1	2	2	3	5
	Tester, battery, starter, generator, regulator.	POD-T-388	Use latest specification. Procurement — Sun #VAT-33 or equal.	For facilities with diesel trucks in lieu of one each #VAT-28 above where more than one is authorized.						5
	Tester, diesel tach and RPM.									
	Tester, Mercury and water menometer.									
*	Tester, cylinder compression, portable.	POD-T-358	Use latest specification. Local procurement — Sun #UCT-48 or equal.			1	2	2	3	3
	Tester, distributor.	POD-T-358	Use latest specification. Local procurement — Allen #22-180, Sun #DT-504, or equal.			1	1	1	1	5
	Tester (analyzer), engine, with oscilloscope and auxiliary testing instruments which, when operated singly or in combination, permit identification of defects within the primary and secondary systems, as well as cylinder compression losses and exhaust emissions.		Local procurement — Sun, Allen, Autoscan (FMC), or comparable brand with infrared capability.			1	2	2	2	5
*	Tester, fuel pump.		Local procurement — Sun #FPT-4 or equal.	1		1	1	1	2	6
*	Tester, positive crankcase ventilation, for checking operation of the system or the valve.		Local procurement — AC #CT3 or equal.	1		1	2	2	4	3

*(Every VMF is required to have at least one of each item marked with an “\*”).*

Mandatory	Description	Specification	Source	Vehicles						Life Expectancy (Year)
				Up to 75	76 to 150	151 to 250	251 to 400	401 to 650	650 to Over	
	Tester, radiator pressure cap used to test for leaks in radiator and pressure cap setting without removing.		Local procurement — AC-PTC-3, Snap-on (or Stant) #ST-255A, with adaptors #A-450 and TA-15, or equal.	1		1	1	2	2	3
	Tester, semitrailer lighting systems, 115 volts ac, and 12 volts dc.		Local procurement — Hastings #1090, Searchliter Model #A-2, or equal.	-	-	-	1	1	1	6
	Tester, transistor regulator.		Local procurement — Sun #TRT-12 or equal.	1	1	1	1	2	8	8
	Tester, vacuum pressure, for measuring manifold vacuum and fuel pump pressure.		Local procurement — Snap-on #MT-14E or equal.	1	1	1	2	2	2	3
	Timing light, separate.		Local procurement — Sun #PTL-45, Hastings #1644, Stewart-Warner #82003 or equal.	1	1	1	2	2	2	3

*(Every VMF is required to have at least one of each item marked with an "\*\*".)*

Exhibit 576

**Safety Equipment**

Mandatory	Description	Specification	Source	Vehicles						Life Expectancy (Year)
				Up to 75	76 to 150	151 to 250	251 to 400	401 to 650	650 to Over	
	Fire Fighting Equipment: For local or state requirements for garages and shops, contact the fire department or fire prevention officials in your area.			The number of vehicles and services is omitted in this category since physical layout of quarters varies among facilities. Request should be made based on actual needs.						
	Extinguishers: Type I-Dry Chemical (for Classes A & B fires): Stored-pressure type, hand portable, size 10, nominal capacity 10 lbs., U.L. Rating 30-B:C, with mounting bracket.	NFPA-10	NSN 4210-00-965-I 107	Install in shop in sufficient quantities to be available within 50 feet of any work area or indoor vehicle parking area. Also for installation in service vehicles, wreckers, and over-the-road vehicles.						10
	Type II-Dry Chemical (for Classes A, B, and C fires): Multi-purpose, stored-pressure type, hand portable, size 10, nominal capacity 10 lbs., U.L. Rating 2A-20-B:C, with mounting bracket.	NFPA-10	NSN 4210-00-889-2491	Install near each exit or stairway entrance. One extinguisher for each 3,000 square feet of floor space or fraction thereof. Install so that travel distance between extinguishers does not exceed 50 feet.						10
	Type II-Halon (for Classes A, B, and C fires): Multi-purpose, stored-pressure type, portable, 22 lbs.	NFPA-12A		Install near computer area .						
	Type I-Carbon Dioxide (for Classes B & C fires): Horn-discharging unit with permanent shutoff valve, size 10, nominal capacity 15 lbs., U.L. Rating 10-B:C, with mounting bracket.	NFPA-10	NSN 4210-00-595-I 779	Install at least one extinguisher within 25 feet of any gasoline dispensing equipment or oil storage area. Adequately protect extinguishers installed in outside areas.						10
	Type II-Carbon Dioxide (for NFPA-10 Classes B & C fires).	NFPA-10	NSN 4210-00-595-I 781	Must be justified.						10
	Wheeled type, size 50, nominal capacity 50 lbs., U.L. Rating 20-B:C.									

*(Every VMF is required to have at least one of each item marked with an "\*\*".)*

Mandatory	Description	Specification	Source	Vehicles						Life Expectancy (Year)
				Up to 75	76 to 150	151 to 250	251 to 400	401 to 650	650 to Over	
	Platform, engine servicing, for use by mechanics when working on engines or other part of vehicles above normal height.	OSHA 29 CFR 1910.29	Local procurement — Bustin Industrial Products, Inc. #225 (20" high by 22" wide), #226 (30" high by 30" wide), #227 (30" high by 60" wide), or equal.	As required.						
*	Scaffold, aluminum, portable. One-piece folded sections snap out (horizontally) and lock in expanded positions. Folding horizontal braces pretension the folding diagonal members for uniform rigidity. Expanded size: 6 ft. high by 4 ft. by 4 ft.	OSHA 29 CFR 1910.28	Local procurement — Up-Right Scaffolds Model 1501 or equal.	As required.						10

*(Every VMF is required to have at least one of each item marked with an "\*\*".)*



Exhibit 577

**Body Shop Equipment**

Mandatory	Description	Specification	Source	Vehicles						Life Expectancy (Year)
				Up to 75	76 to 150	151 to 250	251 to 400	401 to 650	650 to Over	
	Chisel, power, air-operated, for cutting or removing metal panels and other uses. (Same as listed under Service & Repair Equipment.)	OSHA 29 CFR 1910.243	Local procurement — Black & Decker #6221, Chicago Pneumatic #CP-714, or equal.	-	-	1	1	1	2	5
	Drill press, 15" electric, bench or floor model. (Same as listed under Service & Repair Equipment.)		Local procurement — Powermatic #1150 or equal.	-	-	-	-	1	1	5
	Gun (riveter), heavy-duty, hand-operated.	OSHA 29 CFR 1910.243	NSN 5120-00-017-2849	1	1	1	1	1	2	5
	Gun (riveter), heavy-duty, power-operated.	OSHA 29 CFR 1910.243	Local procurement — United Shoe Machine Company Model #PRG-511 or equal.	-	-	-	-	1	2	5
	Hammer, automatic 1,000 blows per minute, air-operated, for large body repair shops.	OSHA 29 CFR 1910.218	Local procurement — Aerosmith #AH-15 or equal.	Must be justified.						6
	Jack, hydraulic, approximately 4-ton capacity, with repair kit, remote control, for use in pushing or pulling bent body panels, posts, frame, etc. Rated and stamped.	OSHA 29 CFR 1910.244	Local procurement — Blackhawk #AZ-10L, Snap-on #BJ-3, or equal.	-	-	1	1	2	2	5
	Jack, hydraulic, approximately 10-ton capacity, remote control, with repair kit, same as above, except heavy duty. Rated and stamped.	OSHA 29 CFR 1910.244	Local procurement — Blackhawk #FZ-1L, Snap-on #BJ-10, or equal.	-	-	-	-	1	1	5
	Jack, hydraulic, transmission, pedestal style. Rated and stamped.	OSHA 29 CFR 1910.244								
	Master tool set consists of the following items:			One set for each body and fender repairman.						
	Dolly, block		NSN 5120-00-223-8484							
	Dolly, fender		NSN 5120-00-221-1638							
	Dolly, heel		NSN 5120-00-529-5508							
	Dolly, rail		NSN 5120-00-221-1637							
	Dolly, shrinking		NSN 5120-00-223-8486							
	Hammer, bumping and finishing, 14 oz.		NSN 5120-00-203-6883							
	Hammer, dinging style, 12 oz.		NSN 5120-00-595-8343							

(Every VMF is required to have at least one of each item marked with an "\*\*".)

Mandatory	Description	Specification	Source	Vehicles						Life Expectancy (Year)
				Up to 75	76 to 150	151 to 250	251 to 400	401 to 650	650 to Over	
	Hammer, offset bumping, 12 oz.		NSN 5120-00-194-1644							
	Mallet		NSN 5120-00-293-3399							
	Pick		NSN 5120-00-024-7211							
	Pick		NSN5120-00-024-7213							
	Pick, surfacing, 1-1/2", 12 oz.		NSN 5120-00-595-8342							
	Pick, surfacing, 1-9/16", 12 oz.		NSN 5120-00-725-6981							
	Spoon		NSN5120-00-293-0842							
	Spoon		NSN 5120-00-293-1204							
	Paint Equipment: Paint Drying Equipment: In some climatic areas, help is needed to expedite paint drying. Infrared lamps, lumine type, are recommended.	NFPA-86A	Local procurement — Binks Mfg., DeVilbiss Co., or equal.	Must be justified.						5
	Paint Masking Equipment: Unit dispenses paper with tape applied on edge from a roller.		Local procurement — Industrial Tape Division, 3-M Company, or equal.	Must be justified.						5
	Full hood forced-air respirator system for paint booth.	OSHA 29 CFR 1910.134								
	Paint Mixing Equipment: The use of the motor vibrator (shaker) type of mixing equipment is recommended. Several makes are available. If equipment is installed in the paint shop, the material must be the "explosion-proof" type.		Local procurement — Red Devil, Inc., Miller Paint Equipment Inc., or equal.	Must be justified.						5
	Paint Spray Outfits: Air-operated, including sorav gun equipped for internal or external mix, pressure or siphon feed, bleeder type, 1-square size, screw type cups, air line filters, pressure regulators, gauges, and controls. At facilities having high-volume refinishing requirements, pot-type material containers and multiple gun distributing system may be justified for assignment.	OSHA 29 CFR 1910.107	Local procurement — Binks #98-1063, Lincoln #MD-82 DeVilbiss, Campbell-Hausfeld, or equal.	Must be justified.						3

(Every VMF is required to have at least one of each item marked with an "\*".)

Mandatory	Description	Specification	Source	Vehicles						Life Expectancy (Year)
				Up to 75	76 to 150	151 to 250	251 to 400	401 to 650	650 to Over	
	Sandblaster, air-operated, with sand tank, rollers, and stand, trigger controlled gun, high-pressure protected hose.		Local procurement — Van Norman #VNKX-17A, Clemco Model SCW 1440, or equal.	Must be justified.						5
*	Sander, air-operated, orbital-action, 3" by 8" sanding pad, 6,000 orbits per minute, well adapted for feather-edging and for use in hard-to-get-at places.	OSHA 29 CFR 1910.213	Local procurement — Black & Decker #6165, National-Detroit Model #150, or equal.	1	1	1	1	2	2	6
	Sander, air-operated, random orbit, 6" diameter pad and sanding disc, up to 12,000 rpm, ideal for feather-edging and body filler.	OSHA 29 CFR 1910.213	Local procurement — Black & Decker #6173, National Detroit Model DA-Q, or equal.	-	-	1	1	2	2	6
	Sander/Grinder, electric, extra heavy-duty, 6,000 rpm, no-load speed, 7" wheel, 115 volt ac, with required safety attachments.	OSHA 29 CFR 1910.213	Local procurement — Black & Decker #6106-09 or equal.	-	1	1	1	1	1	5
	Saw, band (upright) 14" capacity, electric motor, rating 3/4 hp, 125 volts.	OSHA 29 CFR 1910.213(i)	Local procurement — Powermatic #143 or equal.	Must be justified.						10
	Saw, hole, assortments, with arbors, for cutting round holes in metal.	OSHA 29 CFR 1910.213(e)	Local procurement — Simonds, Sioux, Miller Falls, or equal.	1	1	1	1	2	2	1
	Saw, panel cutting, portable, electric, 2-1/2" diameter blade, capacity to 5/8".	OSHA 29 CFR 1910.213(f)	Local procurement — Kett Tool Co. #KS-23-AM, Sioux #3P1460, or equal.	-	-	1	1	2	2	5
	Saw, power metal electric, band, floor type, 1/2 hp motor, 115/250 volts, blade size 8' 2-1/2" long, 5/8" wide, .032" thick.	OSHA 29 CFR 1910.213	Local procurement — Wells Mfg. Corp. #600 or equal.	Must be justified.						10
	Saw, sabre, electric, portable, 2" capacity, high-speed.	OSHA 29 CFR 1910.213	Local procurement — Miller Falls #SP550, Rockwell #667, or equal.	-	-	1	1	2	2	3
	Router and bits, electric, portable 1 hp.	OSHA 29 CFR 1910.213								
	Shear, portable metal cutting electric or air-driven for cutting metal under 18 gauge.		Local procurement — Miller Falls #1611, Sioux #1446, or equal.	-	-	1	1	2	2	3

(Every VMF is required to have at least one of each item marked with an "\*").

Mandatory	Description	Specification	Source	Vehicles						Life Expectancy (Year)
				Up to 75	76 to 150	151 to 250	251 to 400	401 to 650	650 to Over	
	Sheet metal bending machine (Hand Box and Pan Brake), for bending and shaping mild (14 gauge) sheet metal; full set of box and pan fingers, nose bars, bending leaf angle bar, and stop gauge.		Local procurement — Chicago #BP 414-6 or equal.	Must be justified.						15
	Sheet metal cutting machine (Foot Squaring Shear), foot-powered, nominal cutting length capacity 52", for straight shearing of mild (16' gauge) sheet metal.		Local procurement — Pexto #152 or equal.	Must be justified.						15
	Welder, electric, portable. (When separate units are needed for Body Shop, order same item listed under Service and Repair Equipment.)	OSHA 29 CFR 1910.252	Local procurement — Forney #FS230VW or FS295VW, Marquette #1 O-I 19, or equal.	-	-	-	-	1	1	10
	Welding and cutting outfit, oxygen, acetylene. (When separate units are needed for Body Shop, order same item listed under Service and Repair Equipment)	OSHA 29 CFR 1910.252	Local procurement — Victor Super-Range #03840043, with VTS 250C-540 two-stage regulator for oxygen, and VTS #260A-510 two-stage regulator for acetylene.	-	-	-	-	1	2	5
	Welding system, arc, includes welder wire feeder, swivel mount, gas flowmeter.		Local procurement — Hobart #RC256, with wire feeder #AGH-27, or equal.	-	-	-	-	1	1	12

(Every VMF is required to have at least one of each item marked with an "\*\*".)

# 6 Warranty Claims and Defect Reports

## 61 General

---

### 611 **Warranty Recovery Program**

Documentation and recovery of warranted parts, materials, and labor is essential to minimizing fleet costs and to promptly identifying potentially adverse maintenance issues and trends. VMF managers and vehicle post office (VPO) postmasters and managers are responsible for maintaining aggressive warranty recovery programs.

### 612 **Warranty Information**

Manufacturer-specific warranty information and claim procedures for new mail-hauling vehicles are published in a Postal Service *Vehicle Maintenance Bulletin* (VMB) on or about the time of vehicle delivery. Vehicle suppliers and repair parts consignment suppliers may provide warranty procedure manuals, service bulletins, or Web-based systems containing detailed instructions on the disposition of warranty claims and the handling of defective parts. If suppliers provide files electronically to the Postal Service, the information must be in "read-only" format and may not be installed onto Postal Service computer workstations.

### 613 **Warranty Labor Recovery Rate**

For repairs performed by the VMF, use the labor rate for warranty reimbursement most recently published in a VMB. This rate includes both direct personnel and related overhead costs.

**Note:** If a particular vehicle contract establishes manufacturer-specific labor claim rates, the VMB will publish this information.

## 62 Options and Methods for Warranty Repair and Recovery

---

### 621 **Repair by a Dealership or Commercial Repair Facility**

A dealership or other commercial repair facility authorized by the manufacturer may perform repairs with no warranty recovery action required by the VMF, as long as this method does not create excessive additional costs or adverse operational impacts, such as shuttle costs or excessive downtime. When a manufacturer or dealer makes repairs, obtain a copy of the repair order, no-charge invoice, or other form of documentation and place it in the VMF vehicle jacket for reference.

### 622 **Repair and Recovery by a VMF**

When economically feasible and most advantageous to the Postal Service, the VMF should provide the labor for making minor repairs and replacing parts. If the VMF has a bill-back agreement with the manufacturer, code work orders to bill the manufacturer to avoid the cost and delay involved in shuttling the vehicle to and from the authorized dealer. However, this procedure does not preclude the VMF from the requirement of preparing and submitting PS Form 4528, *Vehicle Defect or Deficiency Report*, nor does it preclude the VMF from fully using the dealer when that use is economically feasible.

Before repairing major components such as engines and transmissions, the VMF might have to receive authorization from the manufacturer. Consult manufacturer warranty manuals and service bulletins to ensure that VMF personnel follow proper procedures. Be aware of extended warranty provisions, such as those covering emissions systems. After completing an in-house repair, process the claim utilizing the manufacturer's claim submission system (e.g., online, fax, manual, or other method as specified by the manufacturer). Be aware of time limits for individual claim submissions, in addition to the manufacturer's warranty coverage period (such as 3 years/36,000 miles). Ensure timely submission of claims, regardless of their dollar amount.

Manufacturers typically reimburse VMFs for accepted warranty claims by making bulk payments. Upon receipt of a warranty check from the manufacturer, the VMF must process the check as follows:

- a. In all cases, record the check under General Ledger Account (GLA) 52951.
- b. If the VMF sends the check to the Eagan Service Center, record the check under Account Identifier Code (AIC) 000.
- c. If the VMF deposits the check at a Postal Service retail window, record the check under AIC 168.

The Postal Service will receive a credit to budget line 3A Supplies/Services, Expenses/Reductions. Since VMFs are not established as revenue-generating sites, the credits will usually be reflected in the district or postmaster's finance number. The credit also appears under account code 46 on AEH600P1, *VMAS Mainframe Cost Report in Dollars*. District VMF reports reflect the summed warranty recoveries from all VMFs within the district. Nondistrict VMF reports reflect the individual VMF's recoveries. Each VMF must maintain a master file of claims and supporting documentation, including reimbursement deposit receipts and/or reports.

### 623 **Repair by VMF, With Commercial Recovery Service**

VMFs can also recover repair costs by using a commercial warranty recovery service, which is a fee-for-service option (the fee is typically 8 to 10 percent of the claim value).

To facilitate the commercial warranty recovery service option, the Philadelphia Vehicles Category Management Center (Vehicles CMC) may establish national ordering agreements (NOAs). For information on authorized warranty recovery NOAs and their associated terms and procedures, access the Vehicles CMC Web site at <http://blue.usps.gov/purchase/material/pmsc/philadelphia/dlphi.htm>; click on *National Ordering Agreements & Contracts*.

Typically, a warranty recovery service analyzes copies of vehicle maintenance work orders submitted by a VMF, logs claims, and submits the claims to the manufacturer for payment. The service provider sends the VMF copies of all claims submitted, accepted, and rejected, and issues bulk warranty reimbursements to the VMF. The VMF processes the payments, maintains a master file of claims (as described in part 622), and makes fee payments to the recovery service provider using the IMPAC expense card, unless another method is identified by NOA terms.

**Note:** VMFs may not use the IMPAC repair parts or Voyager commercial cards for fee payments to warranty recovery service providers.

### 624 **Replacement Parts From Stock**

When using replacement parts from stock to repair a vehicle warranty item, issue the part from inventory to the correct vehicle via PS Form 4543, *Vehicle Maintenance Work Order*, under account code 45. Follow the manufacturer's current warranty procedures.

### 625 **Warranty Parts for Vehicles Out of Warranty**

Parts suppliers typically issue credit invoices for warrantable parts that fail on vehicles that are out of warranty. Check with the individual NOA supplier for its policy on failed parts retention and return.

When it receives parts credit invoices from NOA suppliers, the VMF must certify the invoices, retain a copy of each invoice, and forward the original invoices to the San Mateo Accounting Service Center, Accounts Payable

Section. Each invoice must include the NOA number, supplier's tax identification number, and VMF finance number. When the San Mateo Accounting Service Center processes the credit invoices, the recorded finance number receives a credit for line 3H, Vehicle Maintenance, in GLAs 14351.042 and 84351.007. A debit is posted to GLAs 84351.008 and 23439.000.

## 63 Refusal or Delay of Warranty Service

---

If a warranty service provider refuses or disputes a claim, submit a written report to the following address:

DELIVERY VEHICLE OPERATIONS  
 UNITED STATES POSTAL SERVICE  
 475 L'ENFANT PLZ SW RM 7142  
 WASHINGTON DC 20260-2817

Include the following information:

- a. Date vehicle was placed in service.
- b. Vehicle number.
- c. Name of authorized dealer.
- d. Name, title, and telephone number of the individual who refused to provide service.
- e. Nature of defects and reason for refusal.
- f. Mileage at the time of the failure.
- g. Current mileage.

Send a copy of the written report to the area vehicle maintenance staff.

## 64 Reporting Vehicle Defects or Deficiencies

---

### 641 Routine Defects

For vehicles under warranty, immediately report structural or mechanical defects that are not caused by normal wear and tear and that require repair and replacement parts. Use PS Form 4528, *Vehicle Defect or Deficiency Report*. List each failure in detail. Provide the manufacturer's name or the trademark of the parts involved for reference to the manufacturer.

### 642 Urgent Defects

For a defect constituting a serious safety issue (e.g., wheel spindle crack, rubbing brake hose, ruptured vehicle tires, etc.), immediately report the defect to Headquarters Delivery Vehicle Operations at 202-268-3836 and also notify the area vehicle maintenance staff by telephone or e-mail. Include the following information:

- a. Vehicle number.
- b. Date of failure.



- c. Type of failure, including a concise statement describing the failure.
- d. Any accident or injury that occurred due to the failure.
- e. Mileage at the time of the failure.
- f. Current mileage.
- g. Present location of the vehicle.

Confirm reported information by submitting PS Form 4528.

## 65 Adjustments, Repairs, and Defects Not Covered by Warranty

---

### 651 **Adjustments and Repairs**

Normal adjustments or repairs — such as brake lining wear, toe-in, oil, oil filters, antifreeze, and spark plugs — are not usually within the scope of warranty terms. Therefore, for these types of repair actions, do not submit a warranty claim unless there are some very unusual circumstances and the contractor has provided a prior authorization number.

### 652 **Defects**

PS Form 4528, *Vehicle Defect or Deficiency Report*, is not limited to new vehicles. Use this form whenever premature failure of a part, component, or assembly requires replacement prior to normal life expectancy.

I

This page intentionally left blank

# 7 Disposal of Surplus Vehicles, Parts, and Equipment

## 71 Purpose

---

Retention of surplus Postal Service–owned vehicles and vehicle-related parts and equipment (including obsolete items) is costly due to their continuing expense requirements and overall deterioration as a result of prolonged storage. Prompt disposal of surplus vehicles and vehicle-related parts and equipment reduces the Postal Service investment in capital assets, avoids costly and unnecessary maintenance costs, and minimizes vehicle cannibalization costs. Sales can also generate revenue for the Postal Service and contribute to its overall financial position.

## 72 Scope

---

This chapter contains policies and procedures for disposal of surplus Postal Service–owned vehicles and vehicle-related parts and equipment. See also *Postal Operations Manual (POM)*, part 735. For information on recording proceeds of motor vehicle sales, refer to Handbook F-1, *Post Office Accounting Procedures*, subchapter 79.

## 73 Responsibility

---

### 731 Headquarters Vehicle Operations

Headquarters Vehicle Operations (VO) is responsible for directing, evaluating, and monitoring the disposal of vehicles and vehicle-related parts and equipment. This responsibility includes directing the disposal of targeted groups of vehicles, developing and publishing Postal Service policy and procedures, and evaluating sales results and vehicle maintenance facility (VMF) disposal activities.

732 **Philadelphia Vehicles Category Management Center**

The Philadelphia Vehicles Category Management Center (Vehicles CMC) is responsible for enabling disposal-related services such as vehicle preparation, Internet sales of vehicles via online auction, and live auction services.

733 **District Manager**

The district manager, through the manager of Vehicle Maintenance (MVM), is responsible for implementing, directing, evaluating, and controlling all vehicle and vehicle-related disposal activities within the cluster. This responsibility includes identification, notification, and transfer of all excess vehicles to designated locations to meet service needs, and the proper and timely disposal of surplus vehicles.

734 **Manager of Vehicle Maintenance**

The manager of Vehicle Maintenance (MVM) or designee has the following responsibilities:

- a. Ensure the training of all appropriate VMF personnel in vehicle disposal preparation, methods, and procedures.
- b. Determine which vehicles are to be disposed of, ensure their proper preparation for sale, and approve district vehicle sales.
- c. Approve all vehicle disposals requiring the cannibalization and scrap methods.
- d. Ensure that appropriate Postal Service forms are completed and processed properly.
- e. Ensure that vehicle disposal information is promptly and accurately input to the Vehicle Management Accounting System (VMAS) LAN and that resulting changes are reflected in the Vehicle Information Center (VIC) mainframe.
- f. Each month, review mainframe reports AEA850PO1, *VMAS Sub-Ledger/Assigned Location of Vehicle*, and AEA850PO2, *VMAS Subledger/Assigned Location (Storage)*; verify the accuracy of vehicle location and information with the local VMAS/LAN; and correct any discrepancies on the VIC mainframe.
- g. Each month, review report AEA750PO3, *VMAS Vehicle Disposal Listing*, and promptly notify the San Mateo Motor Vehicle Accounting Section (MVAS) of any discrepancy.
- h. Each month, review report AEA925PO1, *Vehicle Sales Analysis Report*, and verify that the gain or loss on sales is correct.

### 735 **Managers/Postmasters**

Local managers and postmasters are responsible for notifying the MVM of excess vehicles for reassignment or disposal as appropriate. Postmasters must comply with established procedures for handling and controlling funds received from vehicle sales conducted by VMFs.

## 74 **Policy**

---

### 741 **Excess Vehicles**

Postmasters and installation heads must identify to the MVM any vehicles determined to be excess to the needs of the function to which the vehicle is assigned. The MVM reassigns the vehicles to meet valid requirements within the cluster, and notifies the area Vehicle Maintenance Programs analyst (VMPA) of vehicles that are excess to the needs of the cluster. The area VMPA then reassigns the vehicles (except excess Postal Vehicle Service (PVS) vehicles — i.e., truck tractors, spotter tractors, cargo vans, or trailers) to meet valid requirements within the area, and notifies VO of remaining excess vehicles. VO reallocates excess non-PVS vehicles to other areas as appropriate and contacts Headquarters Surface Operations for authorization of any PVS vehicle reassignments.

### 742 **Criteria for Disposal**

A vehicle must meet at least one of the following criteria for disposal:

- a. The vehicle has been replaced.
- b. The vehicle is uneconomical to repair.
- c. The vehicle is no longer needed within the Postal Service.

### 743 **Vehicle Storage**

If the MVM determines that a vehicle fits one or more of the criteria for disposal, the MVM has 60 days to store and dispose of the vehicle. The MVM must place such a vehicle into storage as soon as possible after making the decision.

## 75 **Preliminary Vehicle Disposal Procedures**

---

### 751 **Prior Approval**

The MVM provides prior approval for all vehicle disposal transactions. Also, the proper personnel must complete required forms prior to disposal. See subchapter 77.

## 752 **Removal of Mail, Mail-Related Equipment, and Postal Service Decals, Markings, and License Plates**

### 752.1 **Removal of Mail and Mail-Related Equipment**

VMFs must ensure that all mail and mail-related equipment are removed and handled properly.

### 752.2 **Removal of Postal Service Decals, Markings, and License Plates**

VMFs must ensure that Postal Service decals or markings are removed from vehicles prior to their disposal. Under no circumstances may Postal Service mail-hauling vehicles be sold with such decals or markings still on the vehicles. Remove the beltline stripes, eagle logos, vehicle numbers, and other Postal Service markings, including any glue residue or “ghost” markings that indicate the vehicle’s connection to the Postal Service, and repaint as necessary to effect vehicle sale. Remove Postal Service license plates or “P-tags” from all vehicles and record them in the P-tag inventory for reuse or destruction. Remove state license plates and handle in accordance with state requirements.

## 753 **Safety Inspections and Emissions Inspections**

### 753.1 **Safety Inspections**

VMFs have the following responsibilities regarding safety inspections:

- a. Inspect all vehicles offered for sale.
- b. Note all known defects and disclose them to potential buyers or the authorized sales firm.
- c. Inspect tires and brakes to ensure that they meet minimum state specifications. If the applicable state does not require vehicle inspections, refer to *Vehicle Maintenance Bulletin V-07-98*, “Preventive Maintenance Inspection (PMI) Program” (June 1, 1998), as a specification guideline for tires and brakes. Disclose tire and brake measurements to potential buyers or the authorized sales firm.

### 753.2 **Emissions Inspections**

VMFs must provide any applicable emissions inspection information to potential buyers or the authorized sales firm in those states where such an inspection is required. Either the vehicle must be in compliance with the state emissions requirements, or the Postal Service must make the buyer or authorized sales firm aware of the deficiencies. The Postal Service must price the vehicles accordingly.

**754 Cleaning, Body Work, Painting, and Repairs**

Vehicles sold for other than scrap should be presented in clean condition. Invest in paint and minor repairs when those costs can reasonably be recovered through improved sales prices. Generally, vehicle preparation expenses (parts, materials, and labor, excluding decal removal costs) should not exceed 10 percent of the sales price of the vehicle. For each vehicle being prepared, document all preparation expenses on PS Form 4541, *Order-Invoice for Vehicle Repair (Commercial Work Order)*, or PS Form 4543, *Vehicle Maintenance Work Order*, or a contractor invoice. Open work orders are prohibited. When the expense to provide an operable vehicle cannot be justified, sell the vehicle as inoperable and state the reason(s) the vehicle is inoperable on all sales literature and documents.

**755 Warranty and Purchaser's Responsibility**

The Postal Service sells all vehicles "As Is, Where Is" without any guarantee or warranty, written or implied. No employee or agent of the Postal Service has authority to alter this provision. VMF sales personnel must encourage potential buyers to thoroughly inspect vehicles.

The following statement must appear on all sales brochures:

The condition of the item offered is not guaranteed. Deficiencies, when known, have been indicated in the item description. However, absence of any indicated deficiency does not mean that the item may not have deficiencies. Buyers are cautioned to inspect before bidding or buying. The buyer assumes the responsibility and cost to have the vehicle inspected and registered as required by state and local government.

**756 Planning**

When planning a sale, select a sale method and location based on the number and type of vehicles for sale, their condition, and the local market. If selecting a local fixed-price sale, select a location that permits appropriate security during display and safe viewing by the public, and coordinate sales activities with Postal Police and the Inspection Service.

**757 Sales of Related Surplus Items**

VMFs may display and sell separately other surplus vehicle-related parts and equipment via eBay online auctions. Examples are parts, service and parts manuals, and excess rims and tires that cannot be used on vehicles remaining in the fleet. Refer to the Vehicles CMC Web site for eBay preparation, listing, and disposal instructions. Access the Vehicles CMC Web site at [http://blue.usps.gov/purchase/supplies/sup\\_veh\\_home.htm](http://blue.usps.gov/purchase/supplies/sup_veh_home.htm).

The buyer/agent provides the local Postal Service retail sales associate with payment in full by cash, approved credit card transaction, or cashier's check or money order payable to "United States Postal Service." The retail sales associate issues PS Form 3544, *USPS Receipt for Money or Services*, to the buyer/agent. For surplus parts, record the revenue to General Ledger Account 52955.000, "Credits to vehicle supplies/services." For all other surplus, record the revenue to General Ledger Account 54963.156, "Miscellaneous equipment/collections from sales."

## 76 Vehicle Disposal Methods

---

### 761 General

The MVM must dispose of surplus vehicles by one of the following methods, except when VO issues vehicle-specific instructions:

- a. Sales:
  - (1) eBay online auction (for disposal of non-mailhauling sedans, vans, and pickup trucks only).
  - (2) Fixed-price sale, for authorized sales of right-hand-drive (RHD) vehicles to rural carriers only (see section 762.12).
  - (3) Auction sale, for all other vehicles not explicitly covered by items 1 and 2, conducted by an accredited auction firm authorized by the Vehicles CMC (see section 763.3).
- b. Vehicle cannibalization/scrap.
- c. Authorized donation.

**Note:** To request disposal exceptions due to extreme circumstances, submit requests to the manager of VO at Headquarters, who considers requests on a case-by-case basis. The MVM may not pursue alternative methods of sales without written or e-mail authorization from the manager of VO.

### 762 Sales Restrictions

The following restrictions apply to disposal of Postal Service-owned vehicles by the sales method.

#### 762.1 Right-Hand-Drive (RHD) Vehicles

#### 762.11 Quarter-Ton Postal Service Jeeps

Do not sell quarter-ton Postal Service Jeeps under any circumstance except for destruction as scrap.



Jeeps may not be sold or disposed of for any other purpose (including sales to rural route carriers or the general public). Crushing or shredding is the recommended means of disposal. The manager of the VMF (MVMF) must perform the following tasks:

- a. Complete a Vehicle Disposal Agreement (see [Exhibit 762.11](#)).
- b. Obtain the signature of the person who is purchasing and destroying the vehicle.
- c. Ensure that the vehicle is destroyed and that all portions of the Vehicle Disposal Agreement are adhered to.
- d. To the extent practicable, witness the destruction of the vehicles.
- e. Process the completed and authorized PS Form 4587, *Request to Repair, Replace, or Dispose of Postal-Owned Vehicle*, through the same channels as a cannibalized vehicle.

#### 762.12 **Other RHD Vehicles**

The following sales restrictions apply to disposal of other RHD vehicles:

- a. If other RHD vehicles are no longer required for local, district, or area service needs as determined in part 741, area VMPAs advise VO of excess RHD vehicles. VO may reallocate the RHD vehicles to another area, or authorize their disposal and disposal method.
- b. If VO authorizes disposal of other non-Jeep RHD vehicles, offer those vehicles first to rural carriers in accordance with the Memorandum of Understanding entitled "Availability of USPS Surplus Vehicles," which is published on pages 121 and 122 in Handbook EL-902, *Agreement Between the United States Postal Service and the National Rural Letter Carriers' Association*. (This handbook is accessible on the corporate intranet at <http://blue.usps.gov/cpim/ftp/hand/el902.pdf>.) The MVM or MVMF notifies the local Rural Letter Carriers' Association representative and local delivery offices with rural delivery of planned sales of RHD vehicles, at appropriate fixed prices. For 2 business days, the MVM or MVMF offers RHD vehicles only to rural carriers. Rural carriers who purchase RHD vehicles must certify that they will use the vehicles in conjunction with their duties as rural carriers. After 2 business days, the MVM or MVMF disposes of remaining RHD vehicle(s) through an authorized national live auction firm in accordance with item 761a(3), unless VO issues alternative instructions.

Exhibit 762.11

**Vehicle Disposal Agreement****VEHICLE DISPOSAL AGREEMENT**

This Agreement is entered into effective the \_\_\_\_\_ day of \_\_\_\_\_, \_\_\_\_\_ between the United States Postal Service ("USPS") and \_\_\_\_\_, (the "Vendor") for the purpose of permanent destruction of the vehicle(s) listed on Attachment A to this Agreement which is incorporated into and made a part of this Agreement. Any reference herein to a vehicle(s) shall be to those on Attachment A.

Vendor agrees and acknowledges that it is not entitled to any fee or payment of any kind from USPS for the disposal of the vehicle(s) and that its compensation shall be whatever it may obtain from the sale of scrap metal from the vehicle(s).

- a. Vendor will not register the vehicle(s) in any state or possession of the United States nor transport the vehicle(s) to any foreign country.
- b. Vendor will not transfer the vehicle to any third party.
- c. Vendor agrees to comply with all applicable local, state, and federal laws, regulations, and ordinances pertinent to the possession and destruction of the vehicle(s).
- d. Vendor agrees to the immediate permanent destruction of the vehicle(s) but in no case more than 30 days after taking possession of them from the USPS.
- e. Vendor agrees that the term "permanent destruction" shall mean destruction of the following components and any subcomponents of them so they are damaged to the extent that the components and subcomponents cannot be rebuilt or reused except to provide raw material (e.g., scrap metal) for recycling:
  - Vehicle Identification Number
  - Licence Plates
  - Body Frame
- f. Vendor agrees that during performance under this Agreement, the USPS shall have the right to inspect any of Vendor's books and records pertinent to performance of the Agreement, any of its subcontractor's books and records pertinent to performance, and shall have the right to do so for a period three years after completion of destruction of the vehicle(s).
- g. Upon request by USPS, Vendor shall furnish documentary evidence of the permanent destruction of the vehicle(s).
- h. Vendor shall not drive the vehicle(s) except to load on a car carrier or tow device.

THE VENDOR

THE USPS

By: \_\_\_\_\_

By: \_\_\_\_\_

(signature)

(signature)

\_\_\_\_\_  
(printed name)\_\_\_\_\_  
(printed name)\_\_\_\_\_  
(title)\_\_\_\_\_  
(title)

Date: \_\_\_\_\_

Date: \_\_\_\_\_

## 762.2 **Postal Service Personnel**

The following Postal Service personnel are prohibited from purchasing surplus Postal Service–owned vehicles, regardless of the sales method used:

- a. Managers of Vehicle Maintenance (MVM).
- b. Managers of VMFs (MVMFs).
- c. Designees with the authority to declare vehicles excess and/or available for sale, set the initial sales price, or reduce the sales price of vehicles.

The following Postal Service personnel are prohibited from purchasing surplus Postal Service–owned vehicles under the conditions noted:

- a. PCES employees and immediate family members who reside in their household, regardless of the sales method used (with the exception of rural carriers purchasing RHD vehicles).
- b. VMF employees and immediate family members who reside in their household, for any fixed-priced sale or live auction (with the exception of rural carriers purchasing RHD vehicles).
- c. Postal Service employees with direct knowledge of the established reserve price, for eBay online auctions.
- d. Postal Inspection Service and Office of Inspector General employees, for sales by the Inspection Service and Office of Inspector General, including forfeited and seized vehicles.

**Note:** No employee may use Postal Service computer equipment, computer logon IDs, or e-mail accounts for the purpose of participating in online auction sales.

## 763 **Vehicle Sales**

### 763.1 **eBay Online Auction Sale**

### 763.11 **Vehicles CMC Responsibilities**

The Vehicles CMC has established procedures to sell surplus Postal Service–owned vehicles and vehicle-related parts and equipment (including obsolete items) using eBay online auctions. This method is authorized *only* for disposal of non-mailhauling sedans, vans, and pickup trucks, and surplus or obsolete vehicle-related equipment. It allows VMFs to take advantage of eBay’s highly visited and competitive online auction Web site to maximize potential revenue and minimize the VMF’s direct involvement in the sale.

### 763.12 **MVM Responsibilities**

The MVM has the following responsibilities:

- a. Provide the Vehicles CMC with a completed “Table 1 – Required information for listing.” Access this table from the corporate Intranet as follows:
  - (1) Access the Vehicles CMC Web site at  
*[http://blue.usps.gov/purchase/supplies/sup\\_veh\\_home.htm](http://blue.usps.gov/purchase/supplies/sup_veh_home.htm)*.

- (2) Under "Vehicles CMC Information," click on *Downloads*.
  - (3) Under "Downloads," click on *Disposals*.
  - (4) Under "Downloads," click on *Vehicle eBay Disposal Process*.
  - (5) Under "Downloads," click on *SOP for Online Auctions of Excess Vehicles*.
  - (6) When the dialog box appears, either open the file directly or save it to your computer (following other prompts as they appear) and then open it.
  - (7) With the file open, scroll down to the last page of the document to locate Table 1.
- b. Ensure that the vehicle is in appropriate sales condition. Clean the vehicle inside and out and perform basic service (tire pressure, fluids, etc.) as needed. Be accurate about the condition of the vehicle — note any body damage, paint condition, interior tears in seats or carpets, overall mechanical condition, and known defects. Submit digital photos of the vehicle, including any damaged areas, if applicable. eBay allows four free pictures with each listing.
- c. In conjunction with the Vehicles CMC, establish the minimum price acceptable for the vehicle — also known as the "reserve price" — using Kelly Blue Book ([www.kbb.com](http://www.kbb.com)) and Edmunds price guides ([www.edmunds.com](http://www.edmunds.com)) and the factors listed in section 763.2.
- Note:** For all vehicles, including seized vehicles released for sale by the Postal Inspection Service, the Postal Service recommends a reserve price of the wholesale value less 10 percent. The eBay item listing does not show viewers this amount. Once the reserve price is met or exceeded, the eBay listing states "Reserve Price Met," and the bidding continues until the posted end date and time of the sale.
- Note:** Sellers can typically achieve fair market returns by having realistic price expectations and setting enticing reserve price amounts.
- Once the auction has begun, the MVM will not adjust the reserve price of a sales vehicle. If the reserve price is not met by the end of the auction, the MVM and the Vehicles CMC may agree to accept the highest bid, but if in such a case they do not agree to sell the vehicle at the highest bid, they will reevaluate the reserve price and will place the vehicle for auction at a later date.
- d. Designate a knowledgeable VMF point-of-contact to answer all reasonable inquires from potential bidders for any offered vehicle. However, the VMF must not mail, fax, or otherwise transmit VMF and commercial vehicle repair records and other information contained in the vehicle jacket to potential bidders.
- e. For information about payment, release of vehicle, and shipping and transportation, see item 8 of the document "SOP for Online Auctions of Excess Vehicles" (see item 763.12a for directions for accessing this document).

## 763.2 **Fixed-Price Sale**

VMFs can use this method for local sales of non-Jeep RHD vehicles to rural carriers in accordance with section 762.12. The MVM establishes a sales price for each vehicle using a combination of the following:

- a. Postal Service asset and salvage value (VMAS subledger/VIC).
- b. Local demand and local market knowledge.
- c. Vehicle condition.
- d. Other requirements or guidelines issued by VO.

The MVM should base the sales price on several factors:

- a. Getting as high a price as possible without incurring undue expense in sales preparation, sales activities, or prolonged retention in inventory.
- b. Setting the price between the wholesale and fair-market values, using the subledger figures as a guide.
- c. Giving consideration to the prevailing price in the area for a comparable vehicle.

If vehicles will be displayed on Postal Service premises, notify the senior site official, the Postal Police, and the Postal Inspection Service. When planning a sale, consider heightened security requirements and the safety of Postal Service employees.

Vehicles are sold to rural carriers on a first-come-first-served basis. Have the vehicle jackets available for all sales vehicles listed.

The MVMF may reduce the sales price of a vehicle by a maximum of 10 percent below the initial sales price without approval from the MVM. The MVM may reduce the sales price of a vehicle by a maximum of 20 percent below the initial sales price without additional action. To reduce the initial sales price by more than 20 percent, the MVM must initiate another PS Form 4594, *Vehicle Sales Request and Report*, to reflect the reduction (see subchapter 77).

## 763.3 **Live Auction Sale**

A live auction sale allows up to 50 vehicles to be sold during a short period of time. Auction sales must be conducted by professional auctioneers approved by the Vehicles CMC, in accordance with the following limitations:

- a. The MVM or MVMF is responsible for removing all Postal Service decals and markings from the vehicles (as described in part 752) before releasing the vehicles to the auction firm, unless the auction firm is also providing decal removal service for the released vehicles.
- b. The MVM sets the minimum sales price of the vehicle(s).
- c. The MVM or MVMF completes an auction sales vehicle pick-up order (as required by the auction firm); PS Form 4577, *Leased Vehicle Condition Report* (which is used in these cases to note the condition of Postal Service-owned vehicles); Standard Form 97 (SF 97), *The United States Government Certificate of Release of a Motor Vehicle*;

and PS Form 4595, *Postal Vehicle Sale/Purchase Agreement*, except for the price and the purchaser's name and address.

- d. The MVMF or MVM contacts the auction firm when vehicles are to be released for sale. The auction firm must pick up the vehicles within 3 working days after receipt of the pick-up order.
- e. The maximum number of vehicles that an auction firm may have in its possession "in process" to sell for any single VMF shall not exceed 50 vehicles.
- f. The auction firm must sell each vehicle within 30 days of receipt. The auction firm may not impose vehicle storage fees.
- g. The auction firm has the right to reduce the price of any vehicle up to 5 percent, at the time of sale, should such an adjustment be appropriate in light of changed market conditions. The auction firm may not sell any vehicle for less than 95 percent of the minimum sales price established by the MVM without written approval from the MVM.

## 764 **Vehicle Cannibalization/Scrap**

Vehicle cannibalization is normally the most expensive means of vehicle disposal, so the Postal Service does not encourage this option. To be cannibalized, a vehicle must meet at least one of the following criteria:

- a. The condition of the vehicle precludes any reasonable return from sale.
- b. The VMF has an immediate need for a specific component or part that cannot be reasonably acquired through conventional supply channels.

The MVM or MVMF must provide justification on PS Form 4587, *Request to Repair, Replace, or Dispose of Postal-Owned Vehicle*, and send the completed form to the San Mateo Motor Vehicle Accounting Section (MVAS). All approval blocks must be completed.

**Note:** On PS Form 4587, item 3 (Serial Number) requires the seven-digit Postal Service vehicle number, not the Vehicle Identification Number (VIN).

If the vehicle is being cannibalized because it is damaged beyond repair and there was financial recovery from a third party, promptly send a copy of a check or receipt from the responsible party or insurance carrier to the San Mateo MVAS. *If the vehicle will be repaired, do not send PS Form 4587 to the San Mateo MVAS.*

**Note:** Dispose of quarter-ton Postal Service Jeeps as scrap when they are removed from service. Crushing or shredding is the recommended means of disposal. (See 762.11.)

**Note:** VMFs also use PS Form 4587 to authorize repairs that exceed the vehicle's one-time repair limit to a vehicle as defined in [Exhibit 221.211](#). When used for this purpose, retain PS Form 4587 in the vehicle jacket. Do not send a completed and authorized PS Form 4587 to the San Mateo MVAS unless a vehicle has been scrapped and/or cannibalized and is to be removed from the vehicle asset master. The cannibalized or scrapped vehicle cannot be titled.

## 765 **Authorized Donation**

### 765.1 **General**

Headquarters Vehicle Operations (VO) must approve all donations of Postal Service–owned vehicles. A vehicle donated to a suitable local educational institution or museum for static display must present a positive image of the Postal Service. The VMF must ensure that the vehicle’s engine, transmission, and all fluids are removed and that the frame is rendered unserviceable by cutting or similar method.

After the MVM receives approval to donate a vehicle, the VMF must process PS Form 4587, as outlined in part 764.

### 765.2 **Museums (Static Display)**

For a vehicle being donated to a museum or an organization for static display, the VMF must note the following in item 24 of PS Form 4587:

- a. The name and address of the museum or organization to which the vehicle has been donated.
- b. That the vehicle has been donated for display purposes only and is not to be titled or used on the road.

The MVM must provide a copy of the completed and authorized PS Form 4587 to the museum or organization receiving the vehicle to ensure that it understands and agrees that the vehicle is for display purposes and cannot be titled or used on the road.

### 765.3 **Law Enforcement Agencies**

The Postal Inspection Service has the authority to transfer Inspection Service vehicles to other law enforcement agencies. The Inspector-in-Charge must authorize the transfer in writing and must provide the Postal Inspection Service finance number to be charged for the donation. The MVM or MVMF administers the transfer of these vehicles and must complete SF 97, *The United States Government Certificate of Release of a Motor Vehicle*, and must enter the word “DONATION” in the sales price block.

### 765.4 **Foreign Postal Administrations**

The Postal Service may occasionally donate surplus vehicles to foreign postal administrations.

Normally, these donations are in conjunction with international postal agreements. VO must authorize all donations in writing. The MVM or MVMF administers the transfer of these vehicles and must complete SF 97 and must enter the word “DONATION” in the sales price block.

**765.5 Other Requests**

The Postal Service cannot accommodate other requests for donations to local groups (including charitable or public service groups such as fire departments, police, school vocational programs, etc.) One reason is that the Postal Service has a responsibility to ratepayers to ensure that it captures disposal revenues. Another reason is that trying to meet all requests in a fair, reasonable, and equitable manner to the satisfaction of all parties (especially to those whom the Postal Service could not accommodate) would create an undue burden for the Postal Service.

**766 Receipt and Processing of Payment and Release of Vehicle**

The appropriate parties perform the following tasks to complete the receipt and processing of payment and the release of a vehicle:

- a. The MVM or MVMF (or designee) completes, prints, and signs PS Form 4595, *Postal Vehicle Sale/Purchase Agreement*, and provides the buyer/agent with the original signed PS Form 4595 to review and sign.
- b. The buyer/agent reviews and signs PS Form 4595 and returns it to the MVM or MVMF (or designee).
- c. The MVM or MVMF (or designee) makes two copies of the signed PS Form 4595, gives those two copies to the buyer/agent, and keeps the original signed document.
- d. The buyer/agent takes one of the copies of the signed PS Form 4595 to the local Postal Service retail sales associate and provides payment in full with cash, approved credit card transaction, or cashier's check or money order payable to "United States Postal Service." (The buyer/agent keeps the other copy of the signed PS Form 4595 for personal records.)
- e. The retail sales associate issues PS Form 3544, *USPS Receipt for Money or Services*, to the buyer/agent and enters the revenue into General Ledger Account 54965, Account Identifier Code 154, to ensure proper accounting.
- f. The buyer/agent takes the PS Form 3544 back to the MVM or MVMF (or designee).
- g. The MVM or MVMF (or designee) verifies the PS Form 3544 with the location that processed the payment (normally with a local telephone call), makes a copy of the receipt for VMF records, and returns the original receipt to the buyer/agent.
- h. The MVM or MVMF (or designee) completes SF 97 as described in part 774 and releases the vehicle to the buyer/agent.



## 77 Required Forms and Approvals for Vehicle Disposal

### 771 PS Form 4587

PS Form 4587, *Request to Repair, Replace, or Dispose of Postal-Owned Vehicle*, is used to initiate and approve all vehicle dispositions.

- a. When a non-district VMF requests approval to dispose of a vehicle, the MVMF initiates PS Form 4587.
- b. When a district VMF requests approval to dispose of a vehicle, the VMF designee initiates PS Form 4587.

The initiating employee (as described in items 771a and 771b) completes PS Form 4587, including items 22a and b, and forwards the form to the MVM for action. Upon concurrence, the MVM complete items 23a and b, and forwards the form to the manager of Operations Programs Support for action. Upon concurrence, the manager of Operations Programs Support signs and dates item 25 and forwards the form to the district manager for final approval. Upon concurrence, the district manager checks the "Approved" box, completes item 25a, and returns the form to the VMF for the required action.

Only after the district manager grants final approval does the MVM determine the disposal method to be used (sale, cannibalizations/scrap, or donation).

Upon receiving authorization to dispose of the vehicle, the VMF does the following, as appropriate:

- a. For cannibalizations/scrap, send the completed, authorized PS Form 4587 to the San Mateo MVAS, and remove the vehicle from the vehicle asset master. Process PS Form 4587 as outlined in part 764.
- b. For donations, process PS Form 4587 as outlined in part 765 for vehicles being donated for static display.

**Note:** VMFs also use PS Form 4587 to authorize the repairs that exceed the one-time repair limit to a vehicle as defined in [Exhibit 221.211](#). In accordance with *Administrative Support Manual (ASM) Exhibit 892*, the VMF must retain a PS Form 4587 used for this purpose for 1 year after the disposal of the vehicle.

### 772 PS Form 4594

PS Form 4594, *Vehicle Sales Request and Report*, is required to request approval to sell a vehicle, regardless of the sales method. The MVM must approve the completed form prior to the initiation of any vehicle preparation or sales activity.

- a. When a non-district VMF requests approval to sell a vehicle, the MVMF initiates PS Form 4594, completes items a, b, c, and d, signs item 4, and forwards the form to the MVM for approval.
- b. When a district VMF requests approval to sell a vehicle, a VMF designee initiates PS Form 4594, completes items a, b, c, and d, signs item 4, and forwards the form to the MVM for approval.

When the sale is completed, the initiating employee (as described in items 772a and 772b) finalizes PS Form 4594 by completing items e, f, g, i, j, and k, and signs item 6. For an auction sale, the initiating personnel must also record the minimum acceptable bid for each vehicle in item h. The initiating facility files the original of PS Form 4594 in a master file by sales number and files a copy with the vehicle jacket. In accordance with ASM Exhibit 892, the VMF must retain PS Form 4594 for 1 year after the sale of the vehicle.

### 773 **PS Form 4595**

PS Form 4595, *Postal Vehicle Sale/Purchase Agreement*, is required for all vehicle sales transactions, regardless of the sales method. The MVM or MVMF (or designee) must sign page 2 under "Seller's Signature." The VMF gives the original to the purchaser and retains a copy in the VMF sales folder. The VMF must retain PS Form 4595 for 3 years after the sale of the vehicle.

### 774 **Standard Form 97 (SF 97)**

Standard Form 97 (SF 97), *The United States Government Certificate of Release of a Motor Vehicle*, is required for all vehicle sales transactions, regardless of the sales method. This is an accountable, pre-numbered form that is controlled by the MVM. The MVM distributes these forms to VMFs in blocks and in sequential order, as needed, and VMFs must document their receipt.

VMFs must use the forms sequentially. Also, VMFs must keep all spoiled, voided, or cancelled forms on file for 2 years.

The MVM or MVMF (or designee) must do the following with SF 97:

- a. Sign the block titled "Transferor's Signature (Seller)."
- b. Upon the receipt of funds from the vehicle buyer, give the original to the purchaser and complete the reverse side of SF 97, obtaining the source for sales preparation cost from PS Form 4543, *Vehicle Maintenance Work Order*, and/or PS Form 4541, *Order-Invoice for Vehicle Repair (Commercial Work Order)*.
- c. After completing the reverse side of SF 97, forward a copy to the San Mateo MVAS (which will remove the vehicle from the asset master), and retain a copy in the VMF sales folder. In accordance with ASM Exhibit 892, the VMF should retain SF 97 for 4 years after the sale of the vehicle.

# 8 Lost/Stolen Vehicles

The Postal Service must be vigilant concerning the security of its vehicles. VMF staff must work closely with its customers and the law enforcement community to immediately report any lost or stolen vehicles.

The Postal Inspection Service works closely with local and national law enforcement agencies to locate lost or stolen vehicles. The following procedures are to be followed if a vehicle owned or leased by the Postal Service is lost or stolen:

- a. All lost or stolen vehicles must be reported to the servicing MVMF immediately. The MVMF will notify local law enforcement, the Postal Inspection Service, and the area Vehicle Maintenance Programs Analyst (VMPA) and will provide them with all pertinent information, including the vehicle description, postal vehicle number, VIN, government license plate number (as applicable), and a copy of any police report. The VMPA will forward the information to Headquarters Delivery Vehicle Operations (DVO).
- b. If the MVM determines that the lost or stolen vehicle cannot be recovered or is no longer useable:
  - (1) The VMPA notifies, in writing, National Accounting at Headquarters of the background and determination.
  - (2) National Accounting at Headquarters authorizes the San Mateo Motor Vehicle Accounting Section (MVAS) to remove the vehicle from the asset master. The Postal Inspection Service provides National Accounting at Headquarters and the MVAS with the disposition of the case and all pertinent information.
  - (3) Upon receipt of the authorization from National Accounting at Headquarters, the MVAS removes the vehicle from the asset master and spools a copy of report AEA750P03, *VMAS Vehicle Disposal Listing*, to the VMF printer.
  - (4) After viewing report AEA750P03 to confirm that the vehicle is properly removed from the asset master, the VMF deletes the vehicle from its local LAN VMAS inventory.

This page intentionally left blank

## Appendix A

# Acronyms and Abbreviations

A/C	Account Code
A/P	Accounting Period
AIC	Account Identifier Code
ASM	Administrative Support Manual
BMC	Bulk Mail Center
BPA	Basic Pricing Agreement
COR	Contracting Officer's Representative
DP	Designated Personnel (to be later defined) Region/Division
DIE	Driver Instructor/Examiner
DOT	Department of Transportation
ELM	Employee and Labor Relations Manual
EPA	Environmental Protection Agency
ERT	Estimated Repair Time
ES	Emergency Service
F/ACT	Form/Action Code
FCC	Federal Communications Commission
FEA	Fuel Efficiency Achievement
FEDSTRIP	Federal Standard Requisition and Issue Procedures
FY	Fiscal Year
FMB	Fleet Management Bulletin
GVW	Gross Vehicle Weight
hd	Heavy Duty
hp	Horsepower
Hz	Hertz (cycles per second)
ICC	Interstate Commerce Commission
LLV	Long Life Vehicle
LTD	Life to Date
M/M	Make/Model
MFO	Manager, Fleet Operations
MVS	Motor Vehicle Service
MVO	Motor Vehicle Operator
N/A	Not Applicable

NHTSA	National Highway Traffic Safety Administration
NSN	National Stock Number
OEM	Original Equipment Manufacturer
OSHA	Occupational Safety and Health Administration
PDC	Postal Data Center
PEDC	Postal Employee Development Center
POA	Privately Owned Automobile
POM	Postal Operations Manual
PVS	Postal Vehicle Service
TEA	Transportation Efficiency Achievement
UL	Underwriters Laboratories
VIN	Vehicle Identification Number
VMAS	Vehicle Management Accounting System
VMEA	Vehicle Maintenance Efficiency Achievement
VMF	Vehicle Maintenance Facility
VMO	Vehicle Modification Order
VOA	Vehicle Operations Analyst
VOMA	Vehicle Operations Maintenance Assistant
VPO	Vehicle Post Office (office with postal-owned or leased vehicles assigned)
WASC	Western Area Supply Center
YTD	Year to Date

## Directive References

### Labels, Notices, and Posters

---

Label 70, *Safety Check and Vehicle Dimensions*

Notice 39, *U.S. Mail (for vehicle display)*

Notice 76, *Expanded Vehicle Safety Check*

Notice 139, *Public Auction — Sale of Used Postal Vehicle* Notice 140, *Sale! Surplus Postal Vehicles*

Poster 49, *Tire Pressure Chart*

Poster 139, *For Sale — Surplus Postal Vehicles*

### Manuals

---

ELM, *Employee and Labor Relations Manual*

POM, *Postal Operations Manual*

### Publications

---

Pub. 24, *Supply Catalog*

Pub. 41, *Procurement Manual*

Pub. 112, *Repair Parts Catalog (microfiche)*

Pub. 184, *Items of Supply, Vehicles (microfiche)*

Pub. 191, *Capital Investment Implementation Instructions Current National Agreement*

Pub. 223, *Directives and Forms Catalog*

## Handbooks

---

Handbook AS-701, *Materiel Management*

Handbook AS-703, *Field Customer Guide to Purchasing and Requisitioning*

Handbook EL-701-A, *New Employee Training for Nonmaintenance*

Employees Handbook EL-701-B, *New Employee Training for Maintenance*

Employees Handbook EL-801, *Supervisor's Safety Handbook*

Handbook EL-827, *Driver Selection. Training, Testing, and Licensing*

Handbook F-1, *Post Office Accounting Procedures*

Handbook F-21, *Time and Attendance*

Handbook F-41, *Vehicle Accounting*

Handbook M-4, *Vehicle Maintenance Program Guidelines*

Handbook M-19, *Accident Investigations — Tort Claims*

Handbook MS-56, *Fire Prevention and Control*

Handbook PO-502, *Container Methods VMAS Microcomputer Operating Guide*



## Appendix C

# Forms Glossary and Record Retention Schedule

<b>From No.</b>	<b>Title/Name</b>	<b>Retentin Instructions</b>	<b>Reference</b>
SF 91	<i>Operator's Report of Motor Vehicle Accident</i>	File numerically by case number. Move to a closed file after the claim is adjudicated. Cut off the closed file each F/Y. Dispose of three years after cutoff.	245.3, 261.23, 267.4, 267.5
SF 95	<i>Claim for Damage, Injury, or Death</i>	File numerically by case number. Move to closed file after the claim is adjudicated. Cut off the closed file each F/Y. Dispose of three years after cutoff.	266.32, 266.571, 267.6
SF 97/97-A	<i>U.S. Government Certificate of Release of a Motor Vehicle</i>	File numerically by VMF sale number. Dispose of 7 years after sale of last vehicle sold on Form 4594.	523, 763.3, 765.3, 766, 774
SF 344	<i>Multi-use Standard Requisitioning/Issue System Document</i>	File each type of form chronologically. Cut off each F/Y. Dispose of one year after cutoff.	524
OF 346	<i>U.S. Government Motor Vehicle Operator's Identification Card</i>	Expires every four years on driver's birthday.	244.24, 244.3, 245.1
087-H	<i>Accident Report Kit</i>	Place in every vehicle operated by any on-duty postal employee (including drive-out agreements).	243.4
PS 1542	<i>Service Point Delivery Requirements</i>	File by location within F/Y. Dispose of after revision.	222.13, 232.1, 232.3
PS 1597	<i>Work Assignment and Mail Count (Messenger Operations)</i>	File by location within F/Y. Dispose of one year after revision.	232.2
PS1700	<i>Accident Investigation Worksheet</i>	File numerically by case number; move to closed file after claim is adjudicated; cut off closed file each F/Y. Dispose of three years after cutoff.	261.23
PS 1769	<i>Accident Report</i>	File chronologically; cut off each F/Y. Dispose of five years after cutoff.	261.23
PS 1804-C	<i>Postmaster's Certification of SDM Equipment Maintenance</i>	File by location; cut off file each FY. Dispose of three years after contract expiration.	245.444
PS 1838	<i>Carrier's Count of Mail — Letter Carrier Routes (Management Summary)</i>	File by location within F/Y. Retain for 2 years.	

<b>From No.</b>	<b>Title/Name</b>	<b>Retention Instructions</b>	<b>Reference</b>
PS 1838-A	<i>Carrier's Count of Mail — Parcel Post and Combination Services Worksheet/Management Summary</i>	File by location within F/Y. Dispose of one year after revision.	232.2, 232.322
PS 1838-B	<i>Parcel Post Firm Delivery Worksheet</i>	File by location within F/Y. Dispose of one year after revision.	232.2
PS 1838-C	<i>Carrier's Count of Mail — Letter Carrier Routes Worksheet</i>	File by location within F/Y. Dispose of one year after revision.	232.2, 232.31
PS 2548	<i>Individual Training Record — Supplemental Sheet</i>	File by location. Retain for 4 years after employee has stopped driving.	273.1
PS 3544	<i>USPS Receipt for Money or Services</i>	Dispose of seven years after cutoff. Cut off file each F/Y after sale of all vehicles listed on PS 4594. Dispose of three years after cutoff.	757, 766
PS 3999	<i>Inspection of Letter Carrier Route</i>	File by location within F/Y. Dispose of one year after revision.	232.2, 232.31
PS 3999-A	<i>Deliveries/Inspection Record — Worksheet</i>	File by location within F/Y. Retain for 2 years.	232.31
PS 3999-B	<i>Inspection of Collection Route</i>	File by location within F/Y. Retain for 2 years.	232.3
PS 4503	<i>Vehicle Delivery Control Sheer</i>	File chronologically by location. Move to inactive file upon disposal of vehicle. Cut off inactive file each F/Y.	221.611, 221.612, 221.613, 221.621, 221.622
PS 45081 4508-A	<i>Vehicle Maintenance Facility Inventory Order and Continuation Sheet</i>	File each type of form chronologically. Cut off the file each F/Y. Dispose of three years after cutoff.	521.2, 555.3
PS 4513	<i>Scheduled/Unscheduled Maintenance Record</i>	File chronologically; cut off each A/P. Dispose of three A/Ps after cutoff.	343
PS 4513-A	<i>Scheduled/Unscheduled Shop Maintenance Record</i>	Same as PS 4513.	343
PS 4515	<i>Vehicle Assignment Justification and Request</i>	Dispose of one year after assignment of vehicle.	221.221, 221.222
PS 4516	<i>Emergency Vehicle Hire Use</i>	File chronologically; retain three years.	221.58
PS 4523	<i>Damage Claim Certification-Hired Vehicle</i>	File numerically by case number. Move to closed file after claim is adjudicated. Cutoff closed file each F/Y. Dispose of three years after cutoff	266.571
PS 4529	<i>Perpetual Inventory Parts</i>	File by location within F/Y. Retain for 3 years.	542.42, 564.1, 564.2
PS 4533	<i>MVS Schedule</i>	Dispose of after revision.	212.5, 213.1, 222.13, 222.22, 222.26
PS 4534	<i>Inventory Adjustment Record and Parts Transferred Between VMFs</i>	File each type chronologically. Cut off file each F/Y; dispose of two years after cutoff.	542.7, 554, 555.3, 555.4
PS 4535	<i>No Value Item</i>	Dispose of with component issued out.	342.3, 542.33
PS 4539	<i>Railroad Van Movement Log</i>	Dispose of six months following revision.	223.52

<b>From No.</b>	<b>Title/Name</b>	<b>Retentin Instructions</b>	<b>Reference</b>
PS 4541	<i>Order-Invoice for Vehicle Repair (Commercial Work Order)</i>	File numerically by vehicle number. Upon transfer, forward with vehicle. Retain for three years after contract expiration.	221.42, 332.2, 457.2, 542.32, 572.5, 754, 774
PS 4543	<i>Vehicle Maintenance Work Order</i>	File chronologically by vehicle number as input to computer on A/P basis. Cut off each F/Y. Retain for three years.	221.42, 342.1, 342.2, 344, 457.2, 458.23, 542.413, 542.42, 542.51, 572.1, 651, 754, 774
PS 4551	<i>Projected Fleet Requirements</i>	Dispose of one year following assignment of vehicle.	323.3
PS 4564	<i>Postal Vehicle Accident Register</i>	File chronologically. Cut off each F/Y. Dispose of three years from date of cutoff.	262
PS 4564-A	<i>Non Vehicle Accident Register</i>	Same as for PS 4564.	262
PS 4565	<i>Vehicle Repair Tag</i>	Dispose of when work order is completed.	452.3
PS 4567	<i>Commercial Servicem Station Procurement Record</i>	File each type of form chronologically. Cut off the file each FN. Retain current and previous year.	221.535, 375.11, 375.133, 375.2
PS 4569	<i>Vehicle Use Plan</i>	Dispose of after revision.	223.1, 223.2, 232.1, 232.2, 232.3
PS 4570	<i>Vehicle Time Record</i>	File chronologically; cut off A/P. Dispose of three A/Ps after cutoff. Exception: Vehicle Hire or Leased, retain for three years after contract expiration.	221.58, 232.3, 245.4
PS 4572	<i>Tractor Log</i>	Dispose of six months following revision.	223.7, 233.33
PS 4574	<i>Daily Record of Gasoline, Diesel Fuel and Motor Oil Issued</i>	File each type of form chronologically: cut off the file each F/Y. Retain current and previous year.	221.535, 373.6, 375.3
PS 4575	<i>MVS Vehicle Survey</i>	File by location within F/Y. Dispose of one year after revision.	233.2, 233.31
PS 4575-A	<i>Five Day Summary — MVS Vehicle Utilization</i>	File by location within F/Y. Dispose of one year after revision.	233.32
PS 4577	<i>Leased Vehicle Condition Report</i>	File numerically by contract. Retain for three years after expiration of contract.	221.541, 221.542, 266.1, 266.2, 266.3, 763.3
PS 4584	<i>Observation of Driving Practices</i>	Send copy to E&LR for inclusion in employee's Form 4582, Operator's Record.	244.233, 244.234
PS 4587	<i>Request to Repair, Replace, or Dispose of Postal-Owned Vehicle</i>	File numerically by vehicle number. Upon transfer, forward with vehicle. See retention for PS 4543-A.	523, 762.11, 764, 765.1, 771
PS 4594	<i>Vehicle Sales Request and Report</i>	Dispose of seven years after sale date of last vehicle sold on form.	763.2, 772
PS 4595	<i>Postal Vehicle Sale/Purchase Agreement</i>	Same as for PS 4594.	763.3, 766, 773
PS 4597	<i>Issuance of Tool Kit — Auto Mechanic</i>	File alphabetically by employee name. Dispose of upon transfer or termination of employee.	561, 563.2, 564.1, 564.4

<b>From No.</b>	<b>Title/Name</b>	<b>Retention Instructions</b>	<b>Reference</b>
PS 4626	<i>Vehicle Fuel and Motor Oil Purchase Record</i>	File each type of form chronologically; cut off file each F/Y. Retain current and previous year.	555.2
PS 4686	<i>Shipping Order</i>	File by location within F/Y. Retain for 3 years.	542.2
PS 4703	<i>Out of Order (Trailer Tag)</i>	Remove from equipment after repair completed; dispose of when work order is completed.	245.13
PS 4984	<i>Repair Parts Requisition</i>	File by location within F/Y. Retain for 1 year.	521.2
PS 5201	<i>Mail Van Inspection</i>	File numerically by sales contract control number. Retain for six months.	221.414, 267.5
PS 5505	<i>Cost Evaluation — Postal Vehicle Service vs. Contract Service</i>	Dispose of one year following assignment of vehicle.	252
PS 7333	<i>Solicitation, Offer, and Award</i>	File numerically by contract number: cut off each F/Y after final payment, conclusion, or cancellation of agreement. Dispose of one year after cutoff.	
PS 7340-A	<i>Shipping Instructions for Excess Property-Vehicles</i>	Dispose of one quarter following assignment of vehicle.	221.63
PS 7376	<i>Abstract of Bids Received</i>	Same as for PS 7333.	
PS 7381	<i>Requisition for Supplies, Services, or Equipment</i>	Same as for PS 7333.	221.52,572.5
PS 7444	<i>Local Purchase Order</i>	Same as for PS 7333.	463.7
PS 8048	<i>Vehicle Hire</i>	File by location; cut off file each F/Y. Dispose of three years after contract expiration.	221.58, 245.444

## Appendix D

# Microcomputer Reports Retention Schedule

<b>Report Title/Name</b>	<b>Retention Instructions</b>
Vehicle Input Worksheet	Dispose of after 3 accounting periods.
Vehicle Inventory	Dispose of after 14 accounting periods.
Parts Inventory	Dispose of after 3 accounting periods.
Employee roster	Dispose of after 3 accounting periods.
Work Order	Dispose of after 1 accounting period.
Fuel and Oil	Dispose of after 3 accounting periods.
Vehicle Utilization	Dispose of after 14 accounting periods.
Reorder for Parts Current	Dispose of after 1 accounting period.
Parts Usage	Dispose of after 3 accounting periods.
Station ID Current	Dispose of after 1 accounting period.
Parts Issue List	Dispose of after 14 accounting periods.
Parts Issus Audit	Dispose of after three accounting periods.

**Reference:** Fleet Management bulletin No. V-60-84.

This page intentionally left blank